

N-Channel Power MOSFET

60V, 6A, 90mΩ

FEATURES

- 100% UIS and Rg tested
- Logic-level gate drive
- Fast switching
- RoHS Compliant
- Halogen-Free according to IEC 61249-2-21

APPLICATIONS

- DC-DC Converters
- Solenoid and Motor Drivers

PRODUCT SUMMARY			
PARAMETER	VALUE	UNIT	
V_{DS}	60	V	
$R_{DS(on)}$ (max)	$V_{GS} = 10V$	90	mΩ
	$V_{GS} = 4.5V$	126	
Q_g	$V_{GS} = 10V$	11	nC



SOT-223

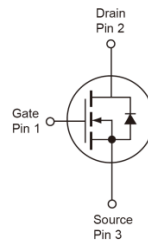
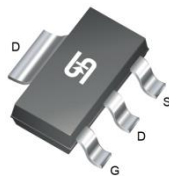

Note: MSL 3 (Moisture Sensitivity Level) per J-STD-020

ABSOLUTE MAXIMUM RATINGS ($T_A = 25^\circ\text{C}$ unless otherwise noted)			
PARAMETER	SYMBOL	LIMIT	UNIT
Drain-Source Voltage	V_{DS}	60	V
Gate-Source Voltage	V_{GS}	± 20	V
Continuous Drain Current (Note 1)	I_D	$T_C = 25^\circ\text{C}$	6
		$T_C = 100^\circ\text{C}$	4
Pulsed Drain Current (Note 2)	I_{DM}	24	A
Single Pulse Avalanche Current (Note 3)	I_{AS}	4.7	A
Single Pulse Avalanche Energy (Note 3)	E_{AS}	11	mJ
Total Power Dissipation	$T_C = 25^\circ\text{C}$	P_D	7.8
Operating Junction and Storage Temperature Range	T_J, T_{STG}	- 55 to +150	$^\circ\text{C}$

THERMAL RESISTANCE			
PARAMETER	SYMBOL	MAXIMUM	UNIT
Thermal Resistance – Junction to Case	$R_{\theta JC}$	16	$^\circ\text{C/W}$
Thermal Resistance – Junction to Ambient	$R_{\theta JA}$	70	$^\circ\text{C/W}$

Note: $R_{\theta JA}$ is the sum of the junction-to-case and case-to-ambient thermal resistances. The case-thermal reference is defined at the solder mounting surface of the drain pins. $R_{\theta JC}$ is guaranteed by design while $R_{\theta CA}$ is determined by the user's board design

ELECTRICAL CHARACTERISTICS ($T_A = 25^\circ\text{C}$ unless otherwise noted)						
PARAMETER	CONDITIONS	SYMBOL	MIN	TYP	MAX	UNIT
Static						
Drain-Source Breakdown Voltage	$V_{GS} = 0\text{V}, I_D = 250\mu\text{A}$	BV_{DSS}	60	--	--	V
Gate Threshold Voltage	$V_{GS} = V_{DS}, I_D = 250\mu\text{A}$	$V_{GS(TH)}$	1.2	1.6	2.5	V
Gate-Source Leakage Current	$V_{GS} = \pm 20\text{V}, V_{DS} = 0\text{V}$	I_{GSS}	--	--	± 100	nA
Drain-Source Leakage Current	$V_{GS} = 0\text{V}, V_{DS} = 60\text{V}$	I_{DSS}	--	--	1	μA
	$V_{GS} = 0\text{V}, V_{DS} = 48\text{V}$ $T_J = 125^\circ\text{C}$		--	--	10	
Drain-Source On-State Resistance (Note 4)	$V_{GS} = 10\text{V}, I_D = 3\text{A}$	$R_{DS(on)}$	--	71	90	m Ω
	$V_{GS} = 4.5\text{V}, I_D = 1.5\text{A}$		--	79	126	
Dynamic						
Total Gate Charge	$V_{GS} = 10\text{V}, V_{DS} = 30\text{V},$ $I_D = 3\text{A}$	Q_g	--	11	--	nC
Gate-Source Charge		Q_{gs}	--	1.4	--	
Gate-Drain Charge		Q_{gd}	--	1.8	--	
Input Capacitance	$V_{GS} = 0\text{V}, V_{DS} = 30\text{V},$ $f = 1.0\text{MHz}$	C_{iss}	--	525	--	pF
Output Capacitance		C_{oss}	--	30	--	
Reverse Transfer Capacitance		C_{rss}	--	24	--	
Gate Resistance	$f = 1.0\text{MHz}$	R_g	--	1.7	--	Ω
Switching (Note 5)						
Turn-On Delay Time	$V_{GS} = 10\text{V}, V_{DS} = 30\text{V},$ $I_D = 3\text{A}, R_G = 1.5\Omega$	$t_{d(on)}$	--	6.5	--	ns
Rise Time		t_r	--	12	--	
Turn-Off Delay Time		$t_{d(off)}$	--	16	--	
Fall Time		t_f	--	1.8	--	
Source-Drain Diode						
Diode Forward Voltage (Note 4)	$V_{GS} = 0\text{V}, I_S = 3\text{A}$	V_{SD}	--	--	1.2	V
Reverse Recovery Time	$I_S = 3\text{A}, V_{GS} = 30\text{V}$ $di/dt = 100\text{A}/\mu\text{s}$	t_{rr}	--	14	--	ns
Reverse Recovery Charge		Q_{rr}	--	10	--	nC

Notes:

- Limited by maximum junction temperature.
- Pulsed width limited by maximum junction temperature.
- $L = 1\text{mH}, V_{GS} = 10\text{V}, R_G = 25\Omega$, Starting $T_J = 25^\circ\text{C}$.
- Pulse test: Pulse Width $\leq 300\mu\text{s}$, duty cycle $\leq 2\%$.
- Switching time is essentially independent of operating temperature.

ORDERING INFORMATION

ORDERING CODE	PACKAGE	PACKING
TSM900N06CW RPG	SOT-223	2.5kpcs / 13" Reel

CHARACTERISTICS CURVES

($T_A = 25^\circ\text{C}$ unless otherwise noted)

Output Characteristics

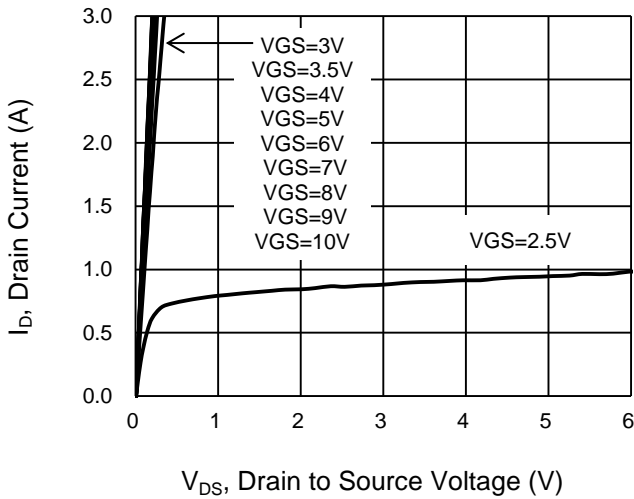

Transfer Characteristics

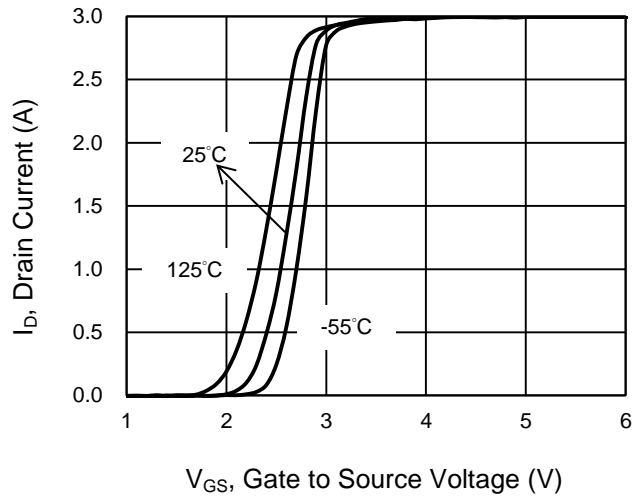

On-Resistance vs. Drain Current

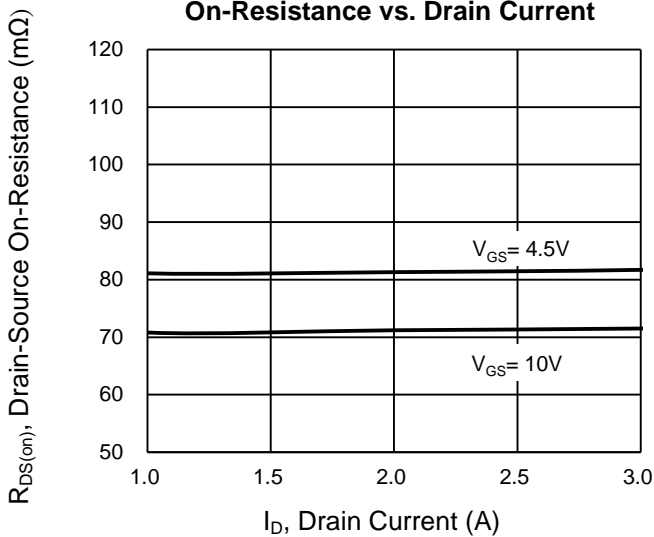

Gate-Source Voltage vs. Gate Charge

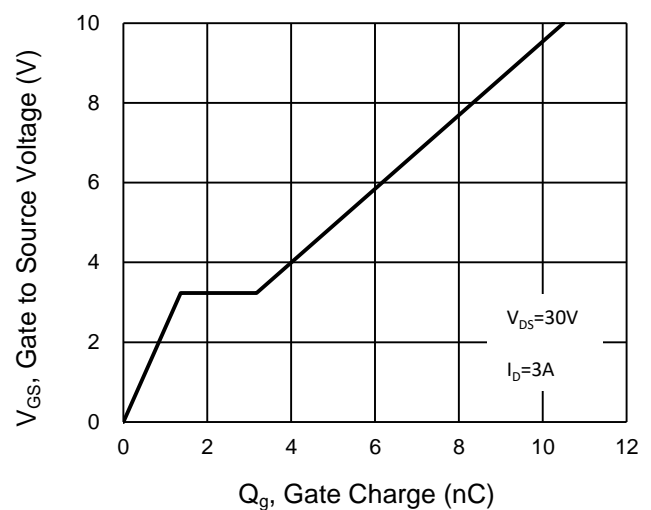

On-Resistance vs. Junction Temperature

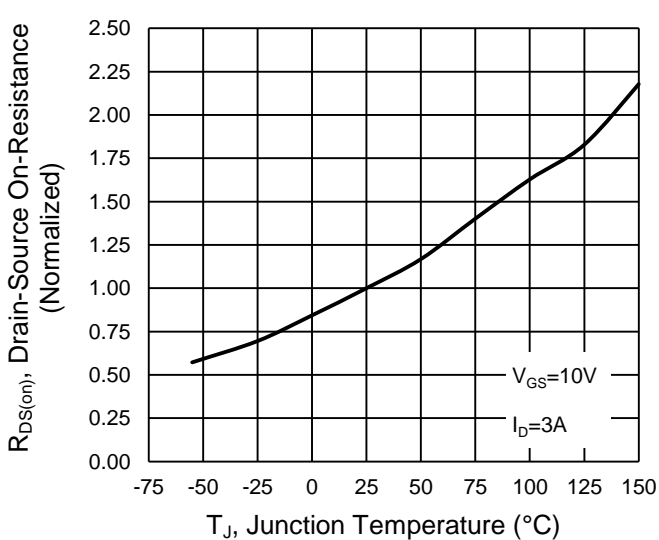

On-Resistance vs. Gate-Source Voltage

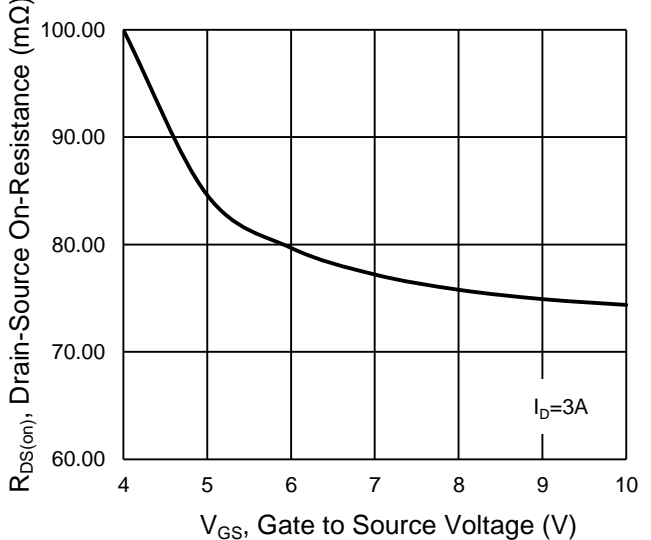

CHARACTERISTICS CURVES

($T_A = 25^\circ\text{C}$ unless otherwise noted)

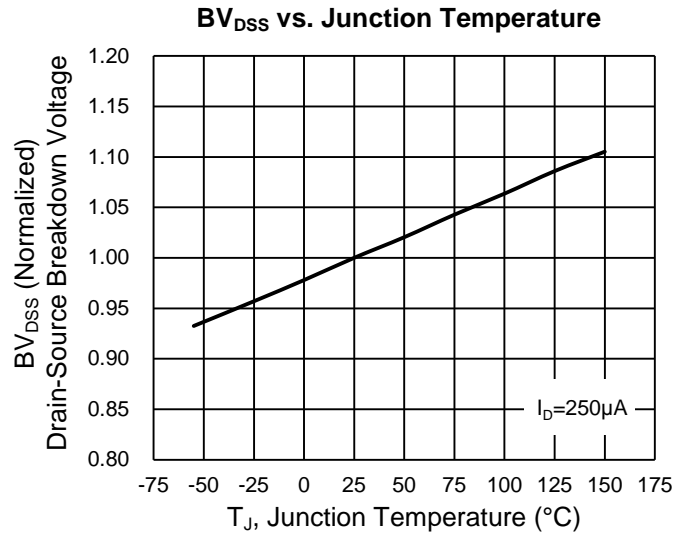
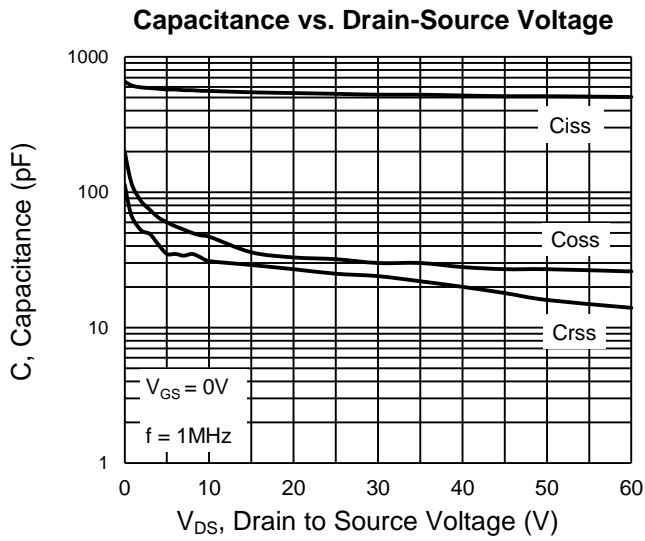

Maximum Safe Operating Area, Junction-to-Case

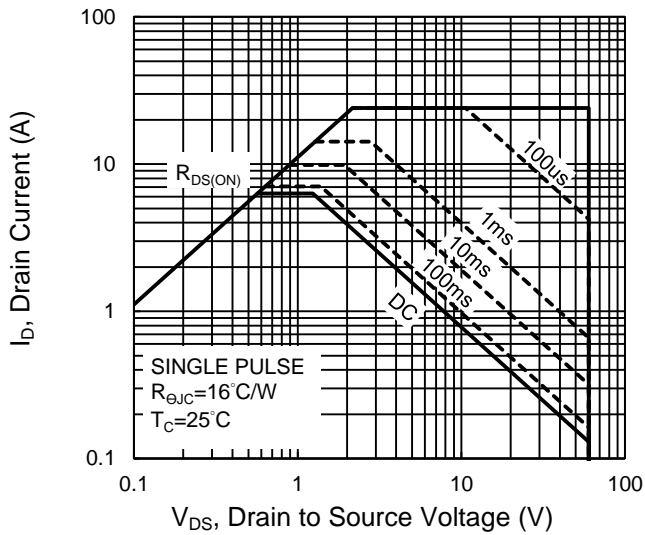

Source-Drain Diode Forward Current vs. Voltage

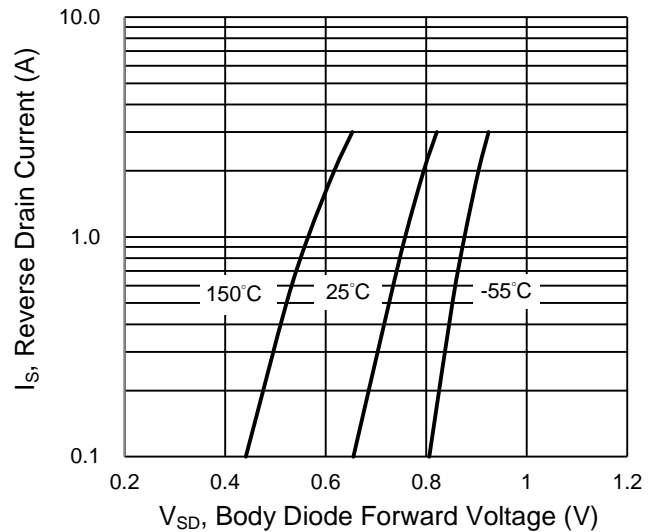

Normalized Thermal Transient Impedance, Junction-to-Cas

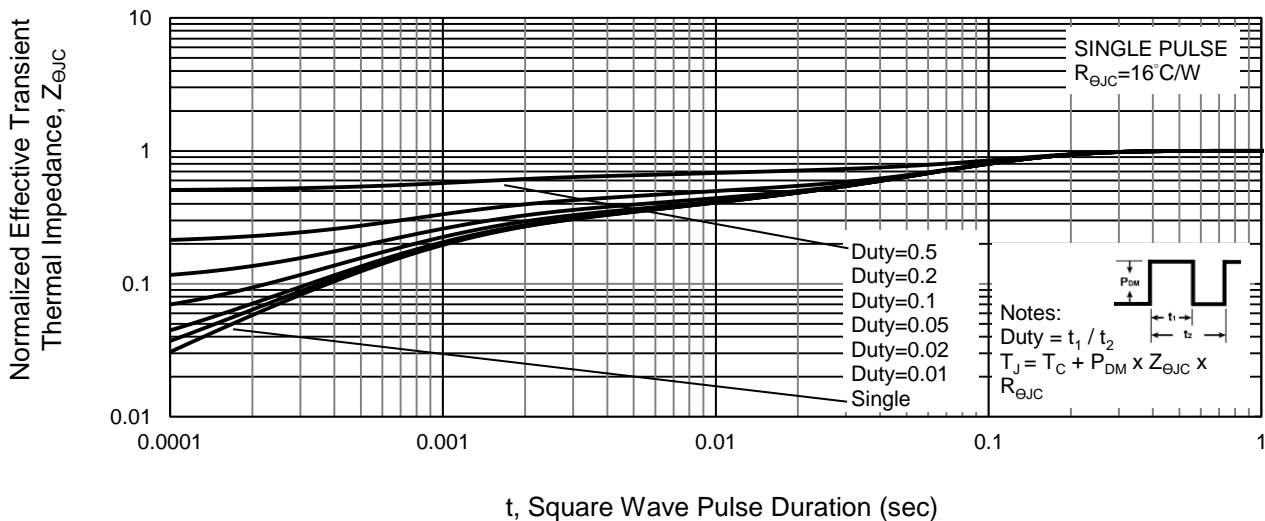

CHARACTERISTICS CURVES

($T_A = 25^\circ\text{C}$ unless otherwise noted)

Power Dissipation

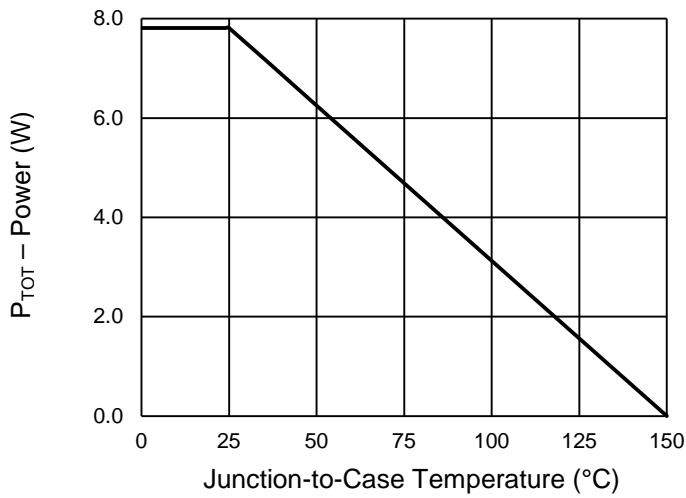

Drain Current

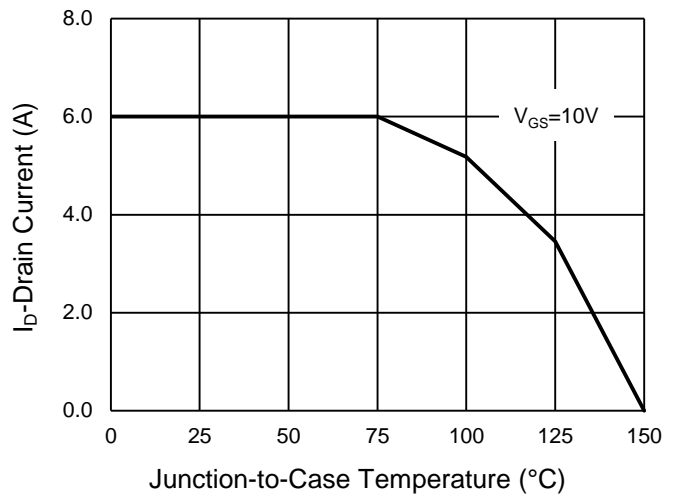

Normalized gate threshold voltage vs Temperature

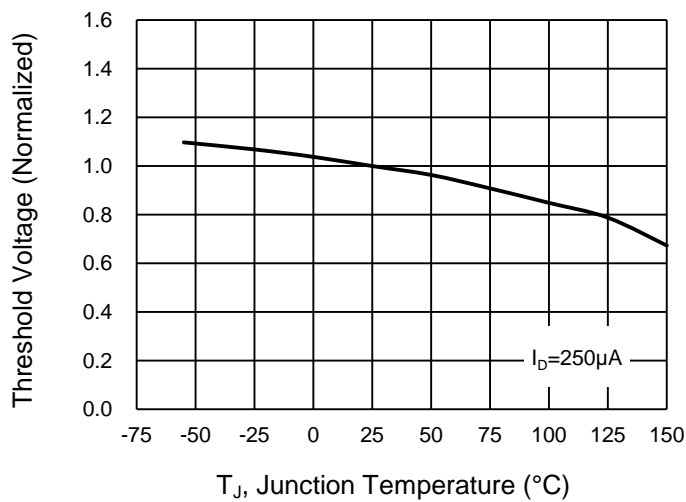

PACKAGE OUTLINE DIMENSIONS (Unit: Millimeters)

SOT-223

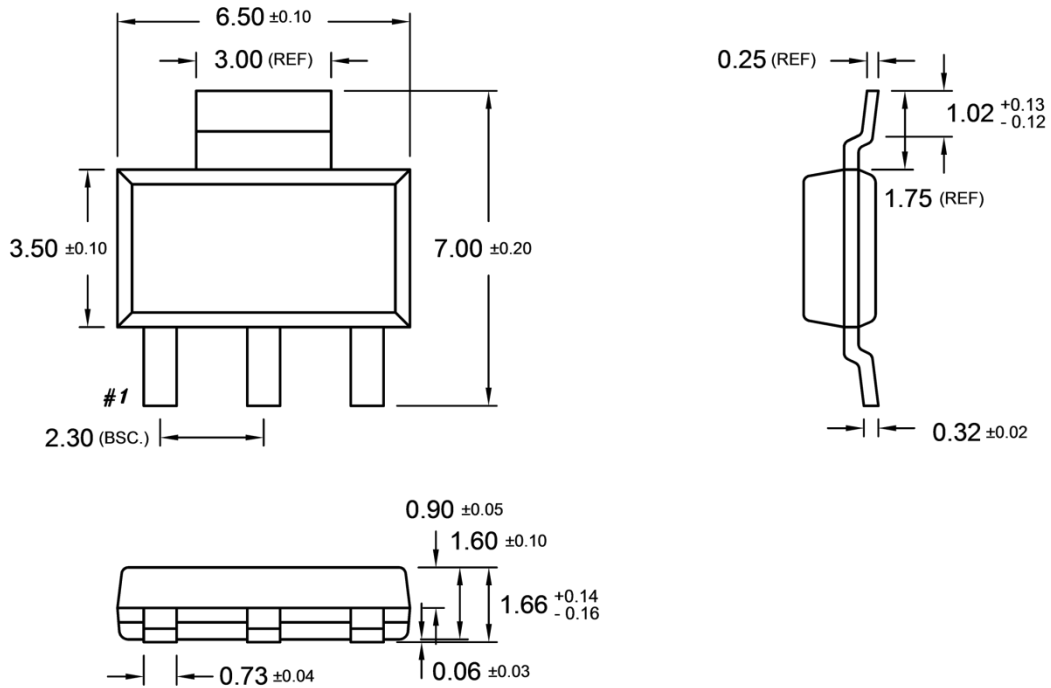

SUGGESTED PAD LAYOUT (Unit: Millimeters)

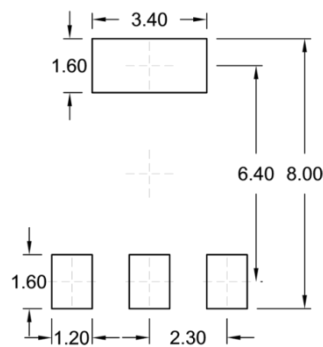

MARKING DIAGRAM

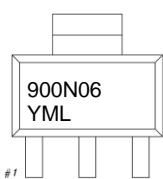

- Y** = Year Code
- M** = Month Code
- O** =Jan **P** =Feb **Q** =Mar **R** =Apr
- S** =May **T** =Jun **U** =Jul **V** =Aug
- W** =Sep **X** =Oct **Y** =Nov **Z** =Dec
- L** = Lot Code (1~9, A~Z)

Notice

Specifications of the products displayed herein are subject to change without notice. TSC or anyone on its behalf, assumes no responsibility or liability for any errors or inaccuracies.

Purchasers are solely responsible for the choice, selection, and use of TSC products and TSC assumes no liability for application assistance or the design of Purchasers' products.

Information contained herein is intended to provide a product description only. No license, express or implied, to any intellectual property rights is granted by this document. Except as provided in TSC's terms and conditions of sale for such products, TSC assumes no liability whatsoever, and disclaims any express or implied warranty, relating to sale and/or use of TSC products including liability or warranties relating to fitness for a particular purpose, merchantability, or infringement of any patent, copyright, or other intellectual property right.

The products shown herein are not designed for use in medical, life-saving, or life-sustaining applications. Customers using or selling these products for use in such applications do so at their own risk and agree to fully indemnify TSC for any damages resulting from such improper use or sale.