

# PerFET™ Power Transistor

## FEATURES

- Ultra-low On-resistance
- 100% UIS and Rg tested
- RoHS Compliant
- Halogen-Free according to IEC 61249-2-21

## APPLICATIONS

- DC-DC Converters
- Solenoid and Motor Drivers
- Load Switch

PRODUCT SUMMARY			
PARAMETER	VALUE	UNIT	
$V_{DS}$	40	V	
$R_{DS(on)}$ (max)	$V_{GS} = 10V$	7	mΩ
	$V_{GS} = 7V$	8.4	
$Q_g$	$V_{GS} = 10V$	21	nC



PDFN33

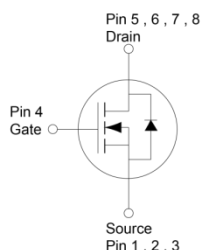

Note: MSL 1 (Moisture Sensitivity Level) per J-STD-020

ABSOLUTE MAXIMUM RATINGS ( $T_A = 25^\circ\text{C}$ unless otherwise noted)			
PARAMETER	SYMBOL	LIMIT	UNIT
Drain-Source Voltage	$V_{DS}$	40	V
Gate-Source Voltage	$V_{GS}$	$\pm 20$	V
Continuous Drain Current, Silicon limited	$T_C = 25^\circ\text{C}$ $I_D$	56	A
Continuous Drain Current (Note 1)	$T_C = 25^\circ\text{C}$ $I_D$	54	A
	$T_C = 100^\circ\text{C}$ $I_D$	35	
	$T_A = 25^\circ\text{C}$ $I_D$	14	
Pulsed Drain Current	$I_{DM}$	216	A
Single Pulse Avalanche Current (Note 2)	$I_{AS}$	17.3	A
Single Pulse Avalanche Energy (Note 2)	$E_{AS}$	44.7	mJ
Total Power Dissipation	$T_C = 25^\circ\text{C}$ $T_C = 125^\circ\text{C}$ $P_D$	36	W
		7.1	
Operating Junction and Storage Temperature Range	$T_J, T_{STG}$	-55 to +150	$^\circ\text{C}$

THERMAL RESISTANCE			
PARAMETER	SYMBOL	MAXIMUM	UNIT
Thermal Resistance – Junction to Case	$R_{\theta JC}$	3.5	$^\circ\text{C/W}$
Thermal Resistance – Junction to Ambient	$R_{\theta JA}$	53	$^\circ\text{C/W}$

Note:  $R_{\theta JA}$  is the sum of the junction-to-case and case-to-ambient thermal resistances. The case-thermal reference is defined at the solder mounting surface of the drain pins.  $R_{\theta JC}$  is guaranteed by design while  $R_{\theta CA}$  is determined by the user's board design.

<b>ELECTRICAL CHARACTERISTICS</b> ( $T_A = 25^\circ\text{C}$ unless otherwise noted)						
PARAMETER	CONDITIONS	SYMBOL	MIN	TYP	MAX	UNIT
<b>Static</b>						
Drain-Source Breakdown Voltage	$V_{GS} = 0\text{V}, I_D = 1\text{mA}$	$BV_{DSS}$	40	--	--	V
Gate Threshold Voltage	$V_{GS} = V_{DS}, I_D = 250\mu\text{A}$	$V_{GS(TH)}$	2.4	3	3.6	V
Gate-Source Leakage Current	$V_{GS} = \pm 20\text{V}, V_{DS} = 0\text{V}$	$I_{GSS}$	--	--	$\pm 100$	nA
Drain-Source Leakage Current	$V_{GS} = 0\text{V}, V_{DS} = 40\text{V}$	$I_{DSS}$	--	--	1	$\mu\text{A}$
	$V_{GS} = 0\text{V}, V_{DS} = 40\text{V}$ $T_J = 125^\circ\text{C}$		--	--	100	
Drain-Source On-State Resistance (Note 3)	$V_{GS} = 10\text{V}, I_D = 27\text{A}$	$R_{DS(on)}$	--	6.2	7	m $\Omega$
	$V_{GS} = 7\text{V}, I_D = 27\text{A}$		--	7.2	8.4	
Forward Transconductance (Note 3)	$V_{DS} = 10\text{V}, I_D = 7\text{A}$	$g_{fs}$	--	36	--	S
<b>Dynamic</b>						
Total Gate Charge	$V_{GS} = 7\text{V}, V_{DS} = 20\text{V},$ $I_D = 14\text{A}$	$Q_g$	--	15	--	nC
Total Gate Charge	$V_{GS} = 10\text{V}, V_{DS} = 20\text{V},$ $I_D = 14\text{A}$	$Q_g$	--	21	--	
Gate-Source Charge		$Q_{gs}$	--	5.6	--	
Gate-Drain Charge		$Q_{gd}$	--	4.8	--	
Input Capacitance	$V_{GS} = 0\text{V}, V_{DS} = 25\text{V},$ $f = 1.0\text{MHz}$	$C_{iss}$	--	1233	--	pF
Output Capacitance		$C_{oss}$	--	249	--	
Reverse Transfer Capacitance		$C_{rss}$	--	31	--	
Gate Resistance	$f = 1.0\text{MHz}$	$R_g$	--	1.6	--	$\Omega$
<b>Switching</b> (Note 4)						
Turn-On Delay Time	$V_{GS} = 10\text{V}, V_{DS} = 20\text{V},$ $I_D = 14\text{A}, R_G = 1.6\Omega$	$t_{d(on)}$	--	10	--	nS
Rise Time		$t_r$	--	45	--	
Turn-Off Delay Time		$t_{d(off)}$	--	19	--	
Fall Time		$t_f$	--	6.1	--	
<b>Source-Drain Diode</b>						
Diode Forward Voltage (Note 3)	$V_{GS} = 0\text{V}, I_S = 27\text{A}$	$V_{SD}$	--	--	1.1	V
Reverse Recovery Time	$I_S = 14\text{A},$ $di/dt = 100\text{A}/\mu\text{s}$	$t_{rr}$	--	28	--	nS
Reverse Recovery Charge		$Q_{rr}$	--	20	--	nC

**Notes:**

- Package current limit.
- $L = 0.3\text{mH}, V_{GS} = 10\text{V}, R_G = 25\Omega$ , Starting  $T_J = 25^\circ\text{C}$ .
- Pulse test: Pulse Width  $\leq 300\mu\text{s}$ , duty cycle  $\leq 2\%$ .
- Switching time is essentially independent of operating temperature.

**ORDERING INFORMATION**

ORDERING CODE	PACKAGE	PACKING
TSM070NH04CV RGG	PDFN33	5,000pcs / 13" Reel

**CHARACTERISTICS CURVES**

( $T_A = 25^\circ\text{C}$  unless otherwise noted)

**Output Characteristics**

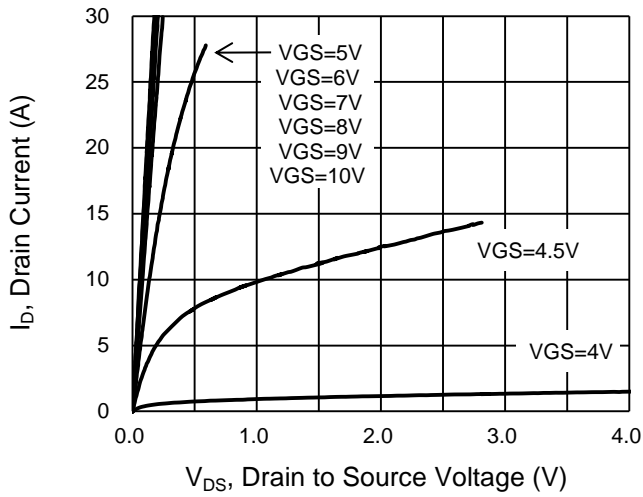

**Transfer Characteristics**

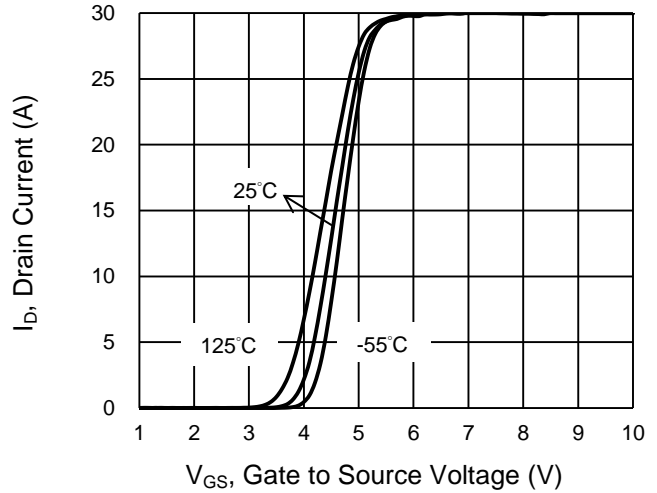

**On-Resistance vs. Drain Current**

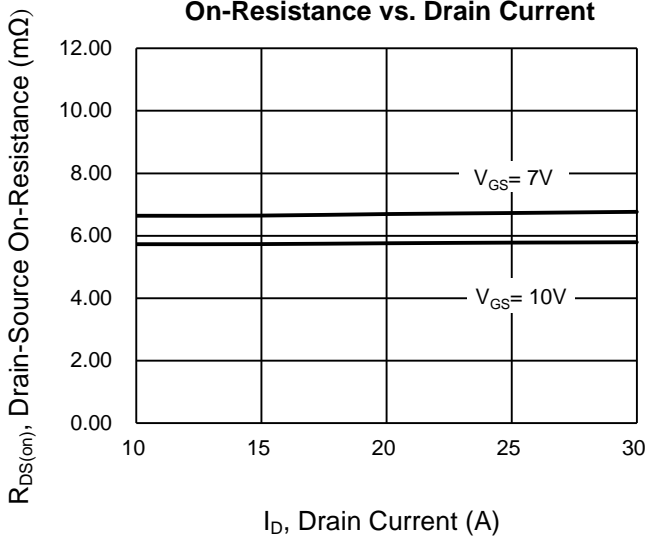

**Gate-Source Voltage vs. Gate Charge**

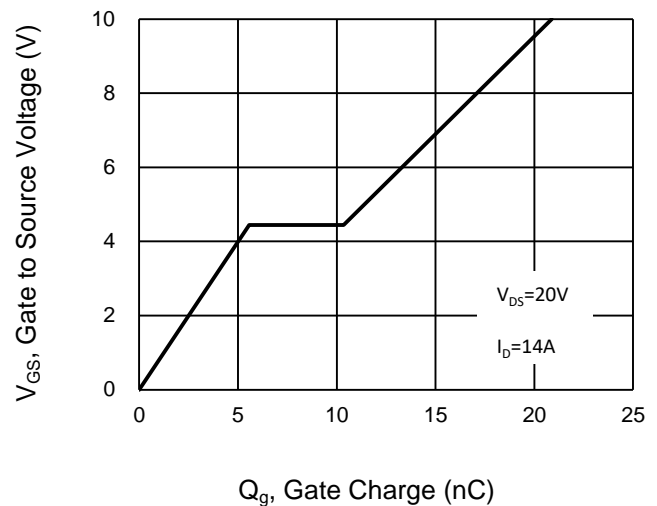

**On-Resistance vs. Junction Temperature**

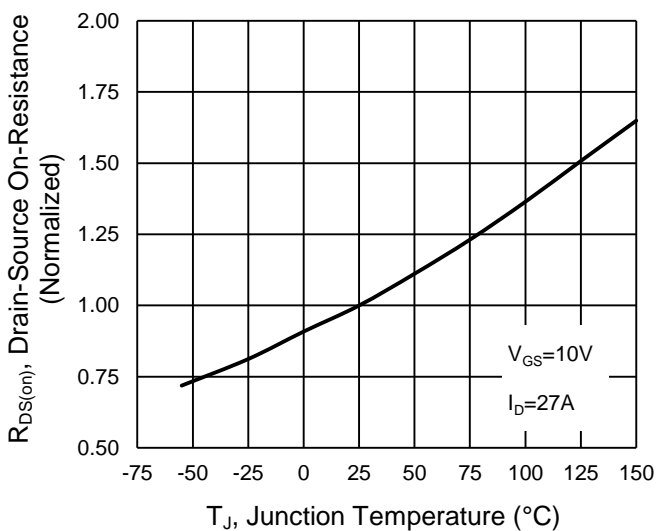

**On-Resistance vs. Gate-Source Voltage**

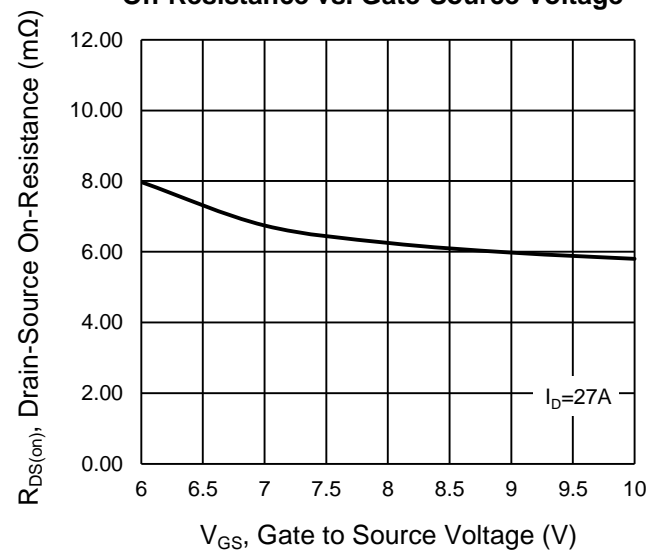

**CHARACTERISTICS CURVES**

( $T_A = 25^\circ\text{C}$  unless otherwise noted)

**Capacitance vs. Drain-Source Voltage**

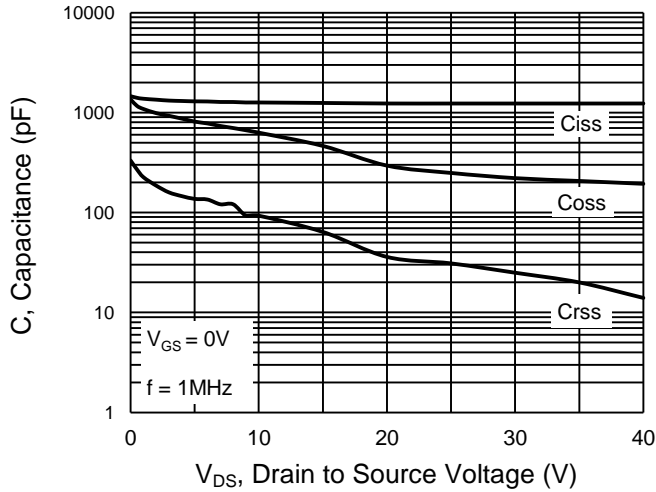

**$BV_{DSS}$  vs. Junction Temperature**

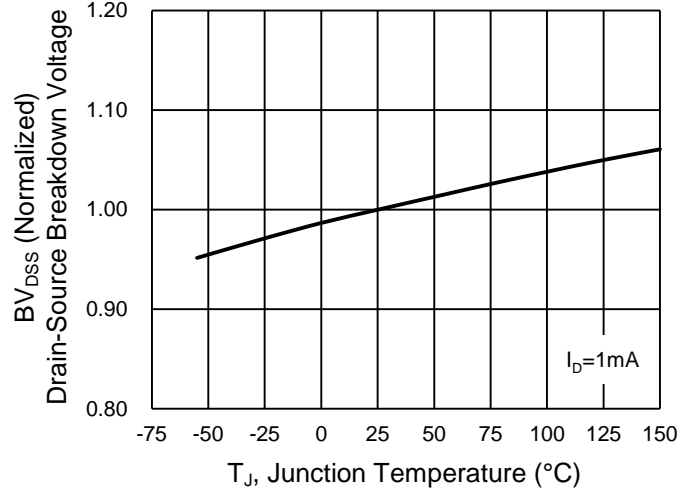

**Maximum Safe Operating Area, Junction-to-Case**

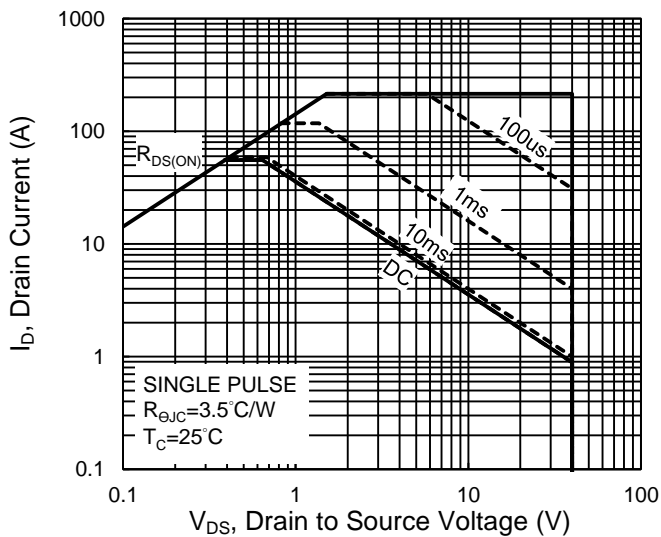

**Source-Drain Diode Forward Current vs. Voltage**

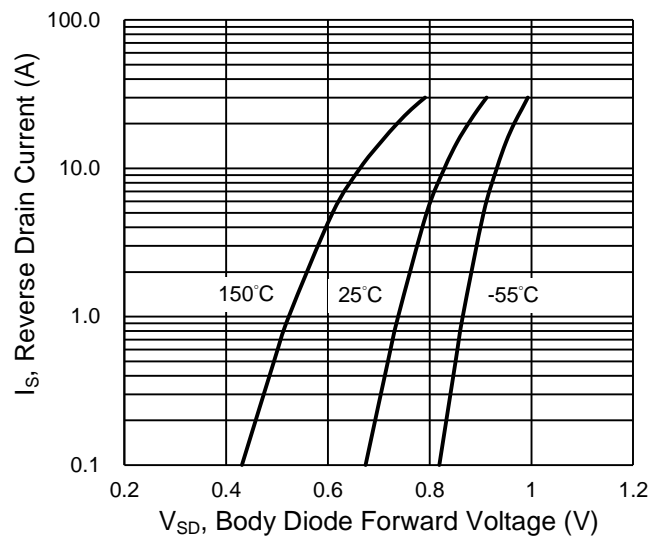

**Normalized Thermal Transient Impedance, Junction-to-Case**

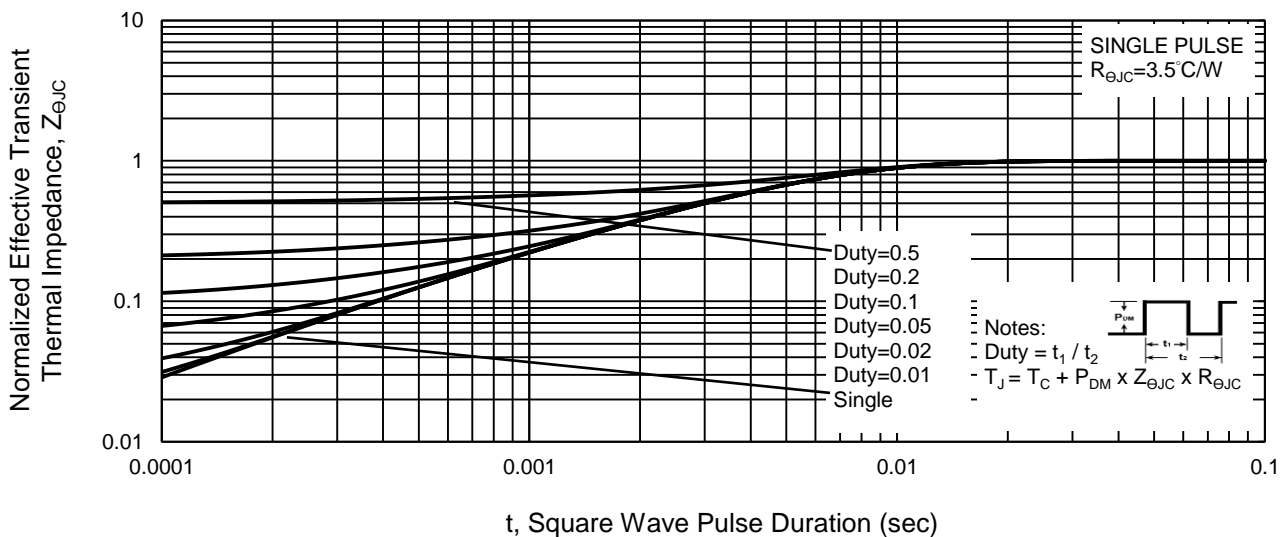

**CHARACTERISTICS CURVES**

( $T_A = 25^\circ\text{C}$  unless otherwise noted)

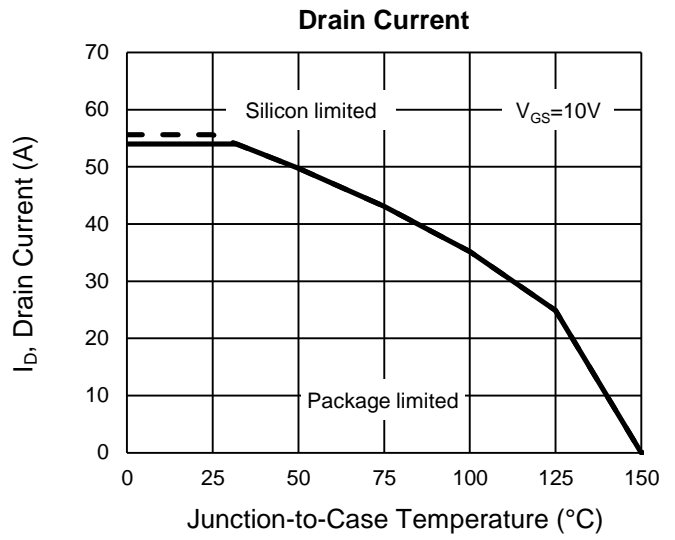
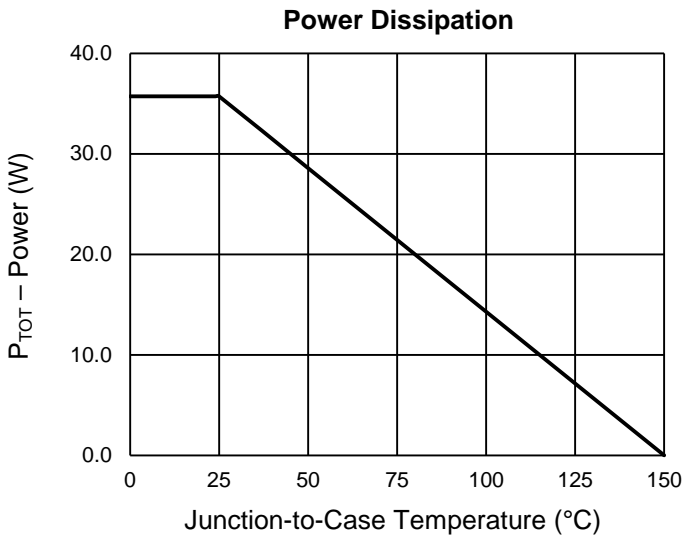

**Normalized gate threshold voltage vs Temperature**

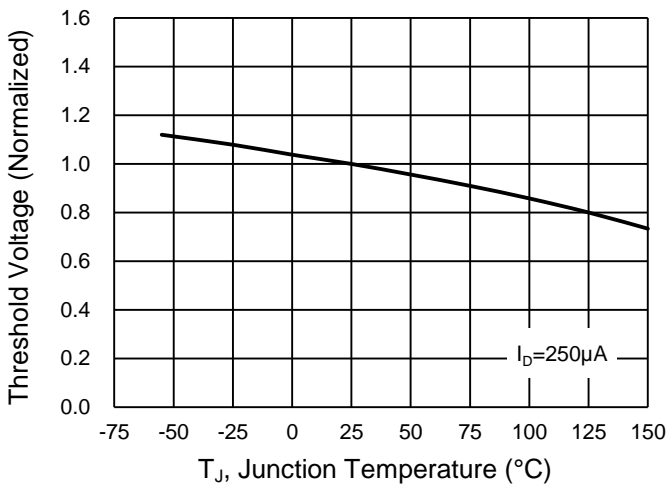

**PACKAGE OUTLINE DIMENSIONS** (Unit: Millimeters)

**PDFN33**

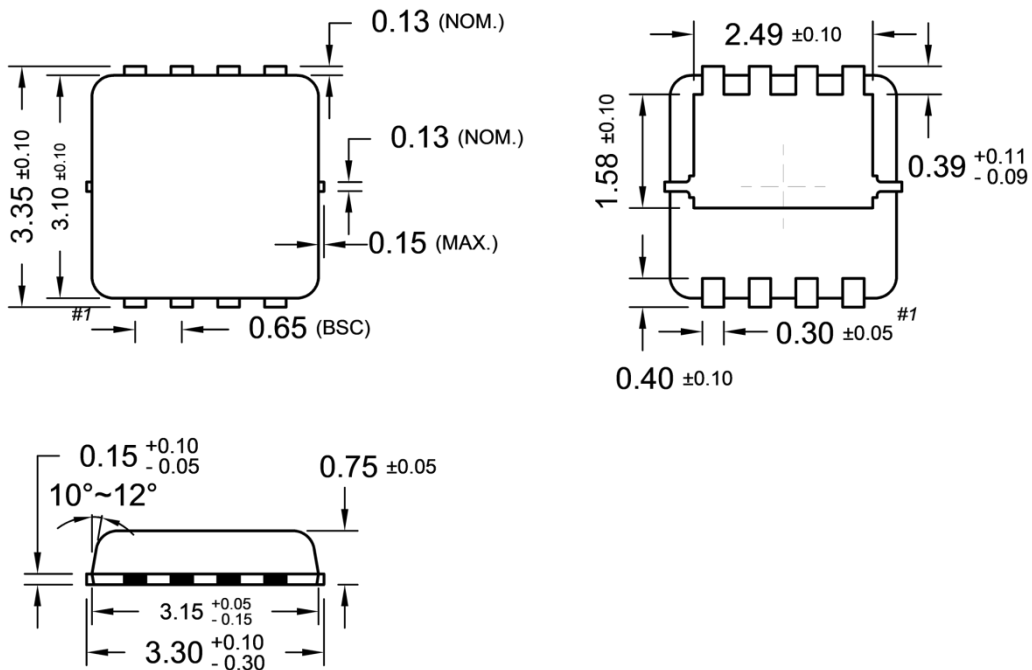

**SUGGESTED PAD LAYOUT** (Unit: Millimeters)

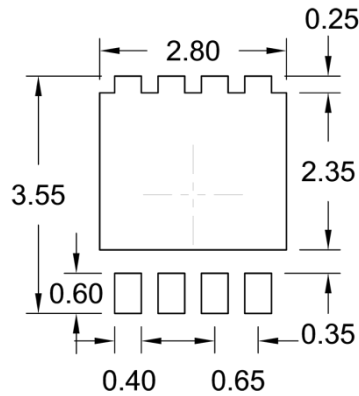

**MARKING DIAGRAM**



- Y** = Year Code
- WW** = Week Code (01~52)
- L** = Lot Code (1~9,A~Z)
- F** = Factory Code

## **Notice**

Specifications of the products displayed herein are subject to change without notice. TSC or anyone on its behalf, assumes no responsibility or liability for any errors or inaccuracies.

Purchasers are solely responsible for the choice, selection, and use of TSC products and TSC assumes no liability for application assistance or the design of Purchasers' products.

Information contained herein is intended to provide a product description only. No license, express or implied, to any intellectual property rights is granted by this document. Except as provided in TSC's terms and conditions of sale for such products, TSC assumes no liability whatsoever, and disclaims any express or implied warranty, relating to sale and/or use of TSC products including liability or warranties relating to fitness for a particular purpose, merchantability, or infringement of any patent, copyright, or other intellectual property right.

The products shown herein are not designed for use in medical, life-saving, or life-sustaining applications. Customers using or selling these products for use in such applications do so at their own risk and agree to fully indemnify TSC for any damages resulting from such improper use or sale.