

Small Signal N-Channel MOSFET

FEATURES

- AEC-Q101 Qualified
- Advanced trench cell design
- ESD protected G-S 2kV (HBM)
- RoHS Compliant
- Halogen-free

APPLICATIONS

- Switching circuits
- High-speed line driver
- Low-side loadswitch
- Relay driver

PRODUCT SUMMARY			
PARAMETER	VALUE	UNIT	
V_{DS}	60	V	
$R_{DS(on)}$ (max)	$V_{GS} = 10V$	1.6	Ω
	$V_{GS} = 4.5V$	2	
Q_g	$V_{GS} = 4.5V$	0.9	nC



SOT-323

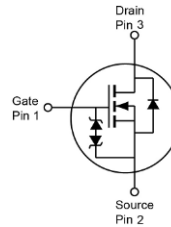
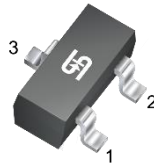

Note: MSL 1 (Moisture Sensitivity Level) per J-STD-020

ABSOLUTE MAXIMUM RATINGS ($T_A = 25^\circ C$ unless otherwise noted)			
PARAMETER	SYMBOL	LIMIT	UNIT
Drain-Source Voltage	V_{DS}	60	V
Gate-Source Voltage	V_{GS}	± 20	V
Continuous Drain Current	I_D	310	mA
Pulsed Drain Current (Note 1)		I_{DM}	1.24
Total Power Dissipation	$T_A = 25^\circ C$	300	mW
	$T_A = 125^\circ C$	60	
Operating Junction and Storage Temperature Range		T_J, T_{STG}	- 55 to +150
°C			

THERMAL PERFORMANCE			
PARAMETER	SYMBOL	LIMIT	UNIT
Junction to Ambient Thermal Resistance (Note 2)	$R_{\theta JA}$	415	°C/W

Notes:

1. Pulse Width $\leq 100\mu s$.
2. Device mounted on an FR4 PCB, single-sided copper, tin-plated and standard footprint.

ELECTRICAL SPECIFICATIONS ($T_A = 25^\circ\text{C}$ unless otherwise noted)						
PARAMETER	CONDITIONS	SYMBOL	MIN	TYP	MAX	UNIT
Static (Note 3)						
Drain-Source Breakdown Voltage	$V_{GS} = 0V, I_D = 250\mu A$	BV_{DSS}	60	--	--	V
Gate Threshold Voltage	$V_{DS} = V_{GS}, I_D = 250\mu A$	$V_{GS(TH)}$	0.5	1.1	1.5	V
Gate Body Leakage	$V_{GS} = \pm 20V, V_{DS} = 0V$	I_{GSS}	--	--	± 10	μA
Zero Gate Voltage Drain Current	$V_{DS} = 60V, V_{GS} = 0V$	I_{DSS}	--	--	1	μA
	$V_{DS} = 60V, V_{GS} = 0V$ $T_J = 125^\circ\text{C}$		--	--	100	
Drain-Source On-State Resistance	$V_{GS} = 10V, I_D = 310mA$	$R_{DS(on)}$	--	1.1	1.6	Ω
	$V_{GS} = 4.5V, I_D = 280mA$		--	1.3	2	
	$V_{GS} = 2.5V, I_D = 100mA$		--	2.2	6.5	
Forward Transconductance	$V_{DS} = 10V, I_D = 310mA$	g_{fs}	--	606	--	mS
Dynamic (Note 4)						
Total Gate Charge	$V_{DS} = 30V, I_D = 310mA,$ $V_{GS} = 10V$	Q_g	--	1.8	--	nC
Total Gate Charge	$V_{DS} = 30V, I_D = 280mA,$ $V_{GS} = 4.5V$	Q_g	--	0.9	--	nC
Gate-Source Charge		Q_{gs}	--	0.3	--	
Gate-Drain Charge		Q_{gd}	--	0.3	--	
Input Capacitance	$V_{DS} = 30V, V_{GS} = 0V,$ $f = 1.0MHz$	C_{iss}	--	28	--	pF
Output Capacitance		C_{oss}	--	8	--	
Reverse Transfer Capacitance		C_{rss}	--	4.2	--	
Switching (Note 5)						
Turn-On Delay Time	$V_{DD} = 30V, R_G = 6.0\Omega,$ $I_D = 310mA, V_{GS} = 10V$	$t_{d(on)}$	--	2.7	--	ns
Turn-On Rise Time		t_r	--	1.8	--	
Turn-Off Delay Time		$t_{d(off)}$	--	8.1	--	
Turn-Off Fall Time		t_f	--	7.6	--	
Source-Drain Diode						
Forward Voltage (Note 3)	$I_S = 310mA, V_{GS} = 0V$	V_{SD}	--	0.9	1.2	V

Notes:

3. Pulse test: Pulse Width $\leq 300\mu s$, duty cycle $\leq 2\%$.
4. Defined by design. Not subject to production test.
5. Switching time is essentially independent of operating temperature.

ORDERING INFORMATION

ORDERING CODE	PACKAGE	PACKING
TQM138KCU RFG	SOT-323	3,000pcs / 7" Reel

CHARACTERISTICS CURVES

($T_A = 25^\circ\text{C}$ unless otherwise noted)

Output Characteristic

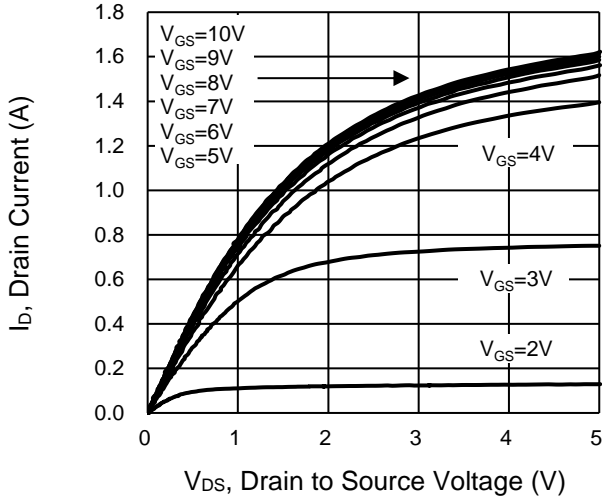

Transfer Characteristics

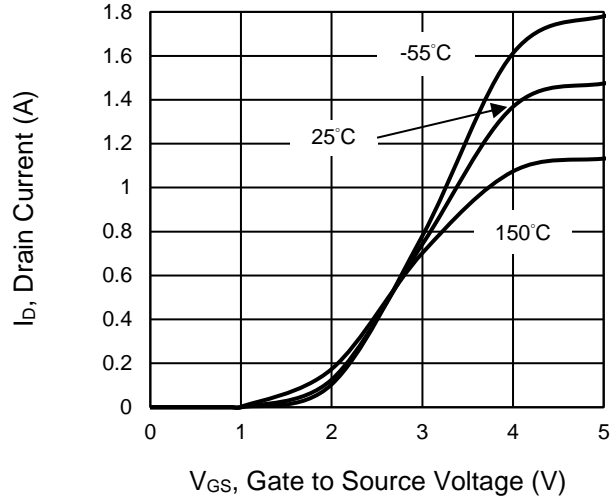

On-Resistance vs. Drain Current

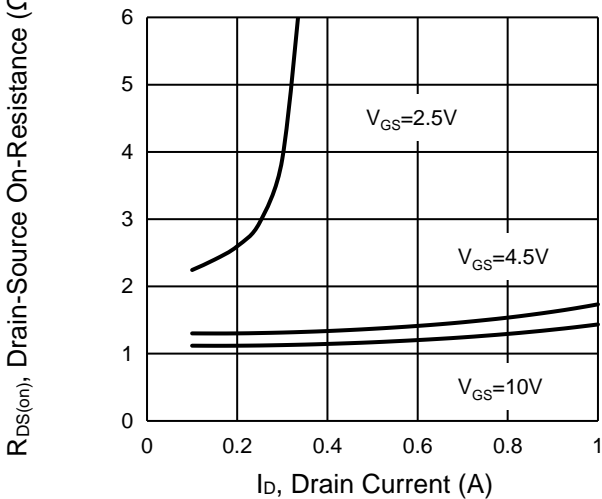

Gate-Source Voltage vs. Gate Charge

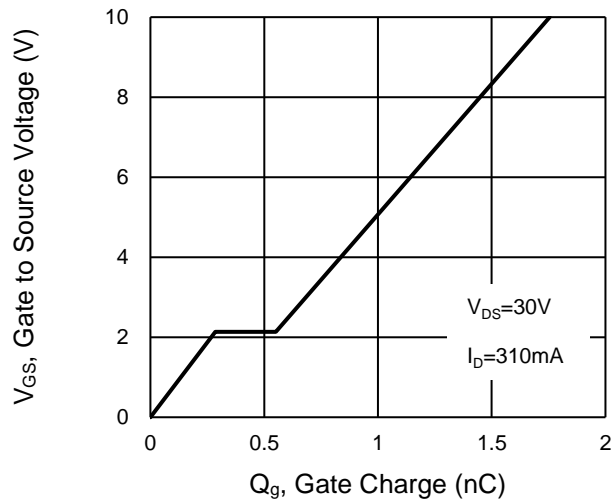

On-Resistance vs. Junction Temperature

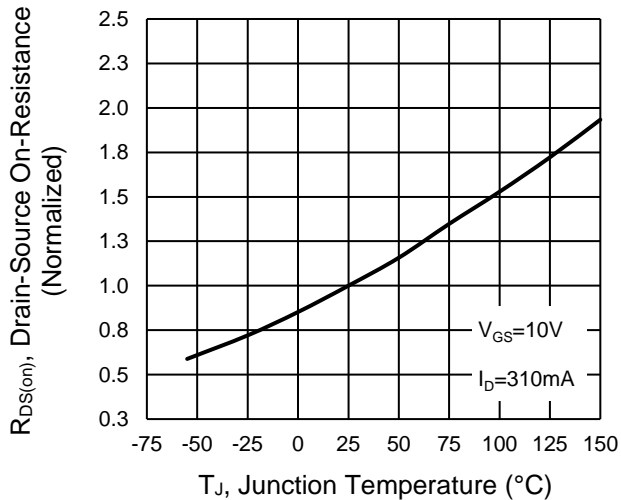

On-Resistance vs. Gate-Source Voltage

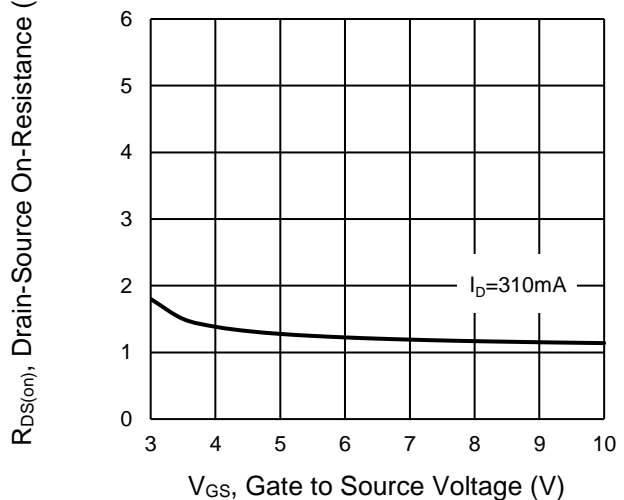

CHARACTERISTICS CURVES

($T_A = 25^\circ\text{C}$ unless otherwise noted)

Capacitance vs. Drain-Source Voltage

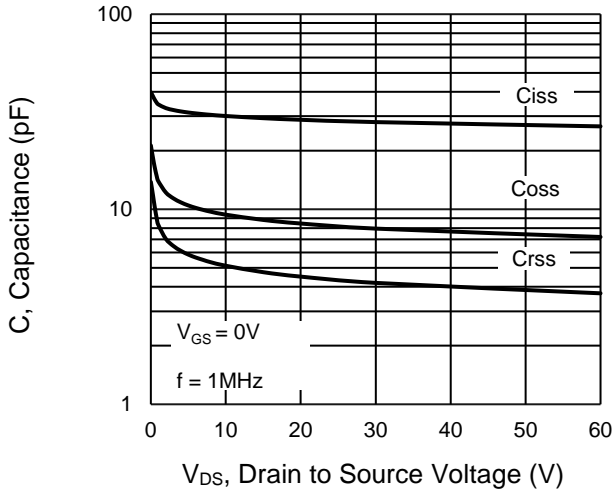

BV_{DSS} vs. Junction Temperature

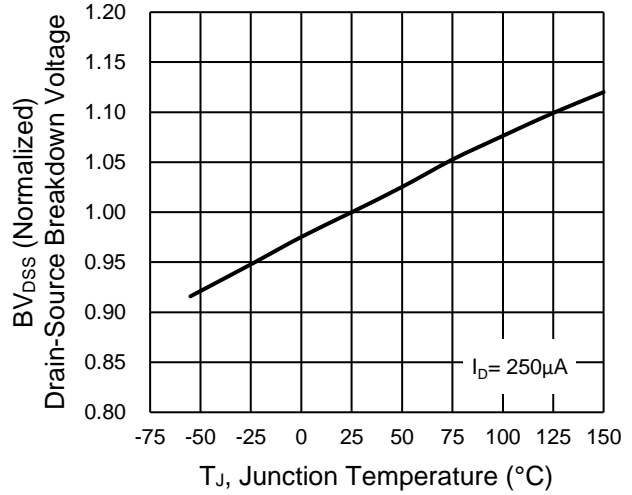

Maximum Safe Operating Area, Junction-to-Ambient

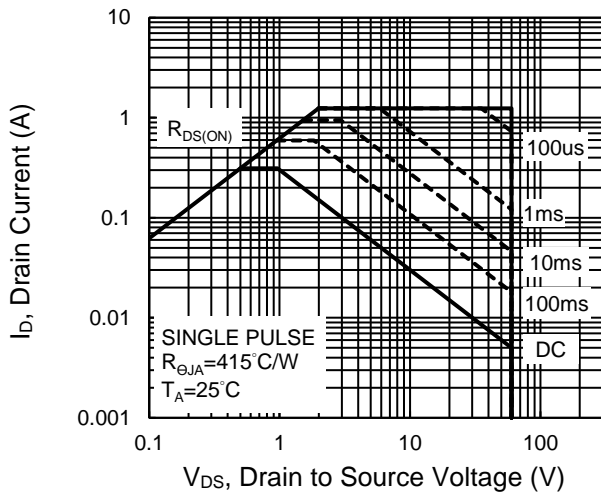

Source-Drain Diode Forward Current vs. Voltage

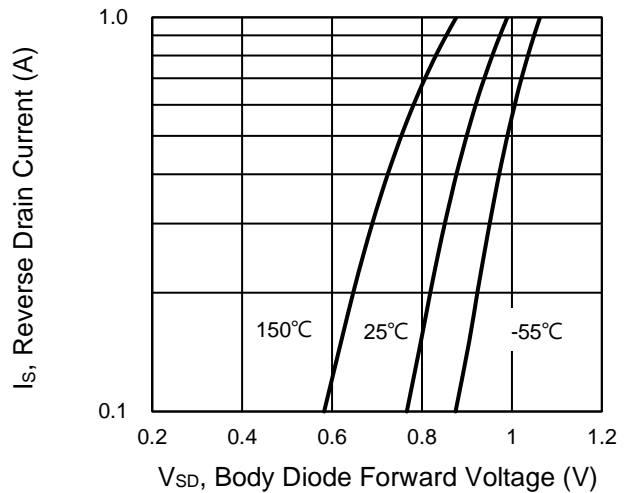

Normalized Thermal Transient Impedance, Junction-to-Ambient

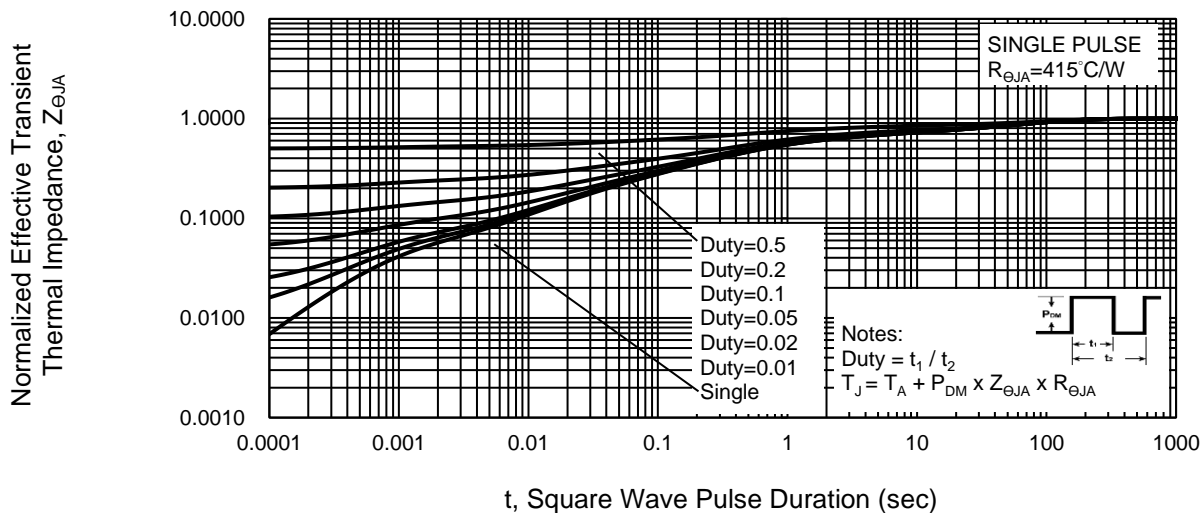

CHARACTERISTICS CURVES

($T_A = 25^\circ\text{C}$ unless otherwise noted)

Power Dissipation

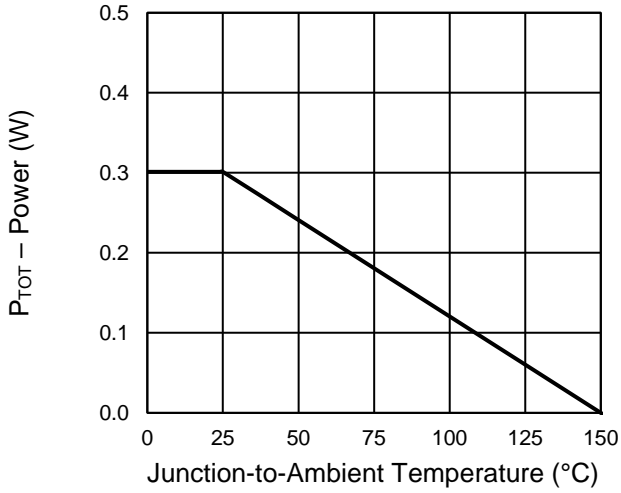

Drain Current

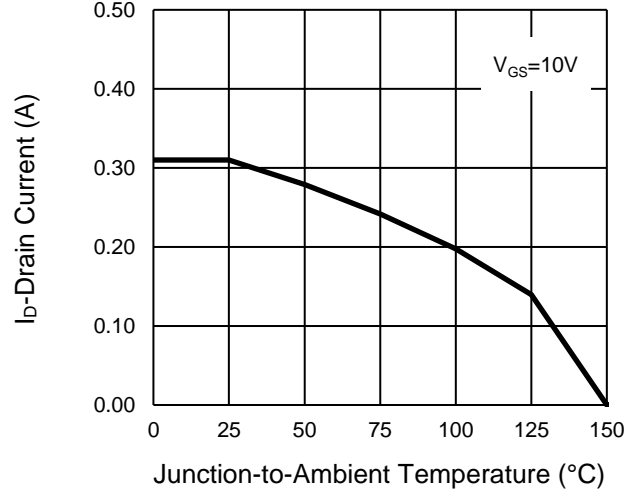

Normalized gate threshold voltage vs Temperature

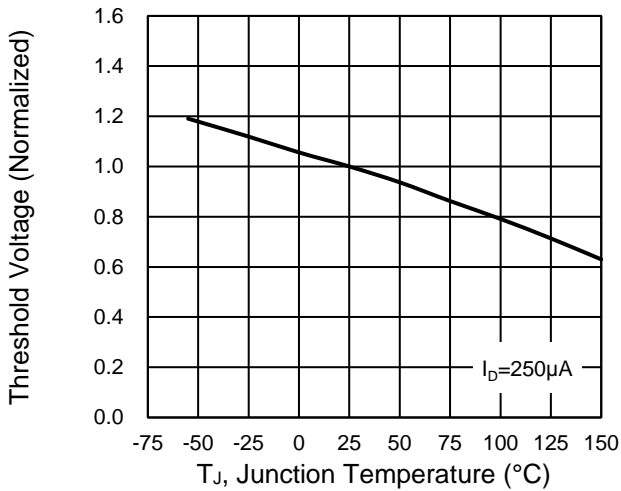

PACKAGE OUTLINE DIMENSIONS (Unit: Millimeters)

SOT-323

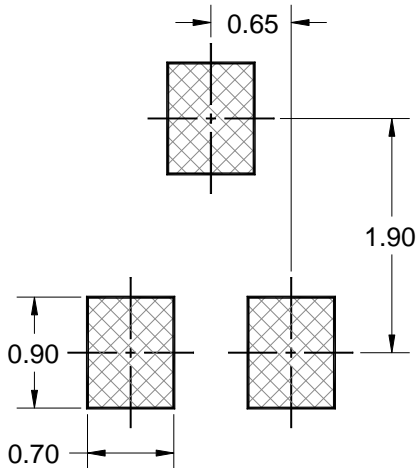
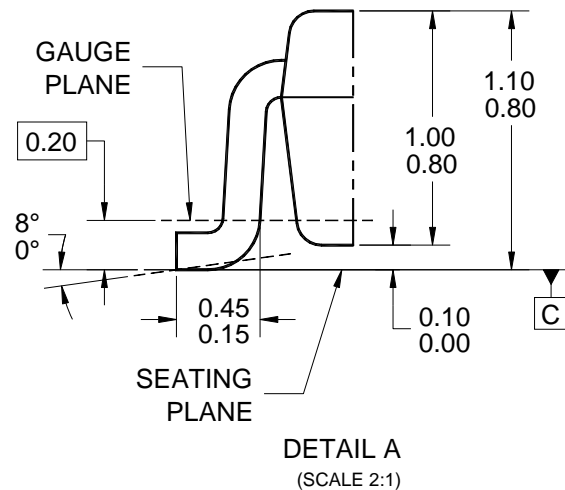
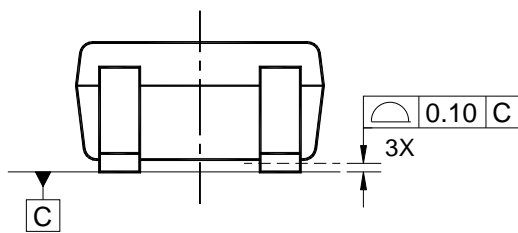
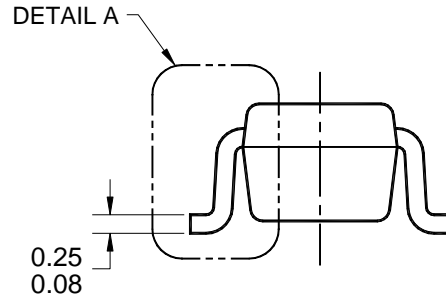
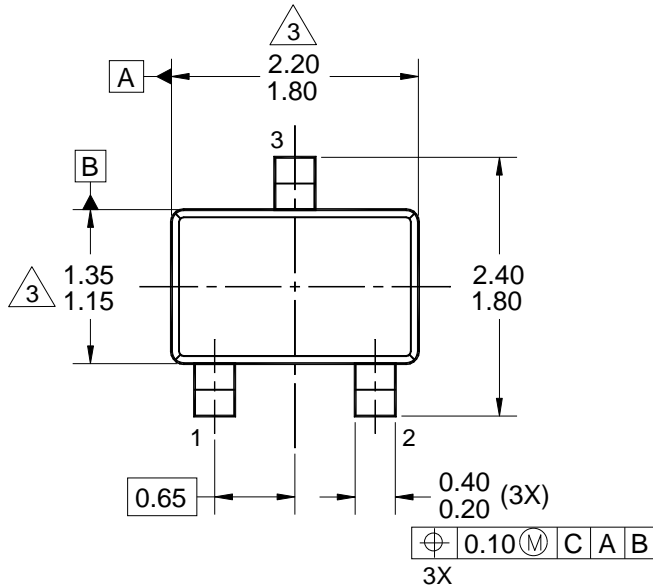

SUGGESTED PAD LAYOUT

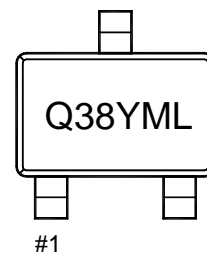

MARKING DIAGRAM

NOTES: UNLESS OTHERWISE SPECIFIED

1. ALL DIMENSIONS ARE IN MILLIMETERS.
2. DIMENSIONING AND TOLERANCING PER ASME Y14.5M-1994.
3. MOLDED PLASTIC BODY DIMENSIONS DO NOT INCLUDE MOLD FLASH, PROTRUSIONS OR GATE BURRS.
4. DWG NO. REF: HQ2SD07-SOT323-098 REV B.

- Y = Year Code
- M = Month Code for Halogen Free Product
(O=Jan, P=Feb, Q=Mar, R=Apl, S=May, T=Jun, U=Jul, V=Aug, W=Sep, X=Oct, Y=Nov, Z=Dec)
- L = Lot Code (1~9, A~Z)

Notice

Specifications of the products displayed herein are subject to change without notice. TSC or anyone on its behalf, assumes no responsibility or liability for any errors or inaccuracies.

Purchasers are solely responsible for the choice, selection, and use of TSC products and TSC assumes no liability for application assistance or the design of Purchasers' products.

Information contained herein is intended to provide a product description only. No license, express or implied, to any intellectual property rights is granted by this document. Except as provided in TSC's terms and conditions of sale for such products, TSC assumes no liability whatsoever, and disclaims any express or implied warranty, relating to sale and/or use of TSC products including liability or warranties relating to fitness for a particular purpose, merchantability, or infringement of any patent, copyright, or other intellectual property right.

The products shown herein are not designed for use in medical, life-saving, or life-sustaining applications. Customers using or selling these products for use in such applications do so at their own risk and agree to fully indemnify TSC for any damages resulting from such improper use or sale.