

PerFET™ Power Transistor

FEATURES

- Excellent FOM
- AEC-Q101 qualified
- Wettable flank leads for enhanced AOI
- 100% UIS and Rg tested
- 175°C operating junction temperature
- RoHS Compliant
- Halogen-free

APPLICATIONS

- Automotive applications
- Solenoid and motor drivers
- DC-DC converters

KEY PERFORMANCE PARAMETERS			
PARAMETER	VALUE	UNIT	
V_{DS}		100	V
$R_{DS(on)}$ (max)	$V_{GS} = 10V$	10	mΩ
	$V_{GS} = 4.5V$	14	
Q_g	$V_{GS} = 4.5V$	13	nC



PDFN56U

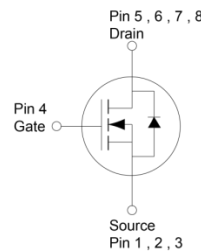
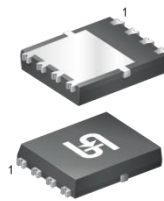

Note: MSL 1 (Moisture Sensitivity Level) per J-STD-020

ABSOLUTE MAXIMUM RATINGS ($T_A = 25^\circ\text{C}$ unless otherwise noted)			
PARAMETER	SYMBOL	LIMIT	UNIT
Drain-Source Voltage	V_{DS}	100	V
Gate-Source Voltage	V_{GS}	± 20	V
Continuous Drain Current	I_D	$T_C = 25^\circ\text{C}$	72
		$T_C = 100^\circ\text{C}$	51
		$T_A = 25^\circ\text{C}$	12
Pulsed Drain Current (Note 1)	I_{DM}	288	A
Single Pulse Avalanche Current (Note 2)	I_{AS}	14.9	A
Single Pulse Avalanche Energy (Note 2)	E_{AS}	33.3	mJ
Total Power Dissipation	P_D	$T_C = 25^\circ\text{C}$	115
		$T_C = 125^\circ\text{C}$	38
Operating Junction and Storage Temperature Range	T_J, T_{STG}	- 55 to +175	$^\circ\text{C}$

THERMAL PERFORMANCE			
PARAMETER	SYMBOL	LIMIT	UNIT
Junction to Case Thermal Resistance	$R_{\theta JC}$	1.3	$^\circ\text{C}/\text{W}$
Junction to Ambient Thermal Resistance (Note 3)	$R_{\theta JA}$	50	$^\circ\text{C}/\text{W}$

Notes:

1. Pulse Width $\leq 100\mu\text{s}$.
2. $L = 0.3\text{mH}$, $V_{GS} = 10V$, $R_G = 25\Omega$, Starting $T_J = 25^\circ\text{C}$.
3. Device on a PCB FR4 with 1 in² (single layer, 2 oz thickness) copper area for drain connection.

ELECTRICAL SPECIFICATIONS ($T_A = 25^\circ\text{C}$ unless otherwise noted)						
PARAMETER	CONDITIONS	SYMBOL	MIN	TYP	MAX	UNIT
Static						
Drain-Source Breakdown Voltage	$V_{GS} = 0V, I_D = 1mA$	BV_{DSS}	100	--	--	V
Gate Threshold Voltage	$V_{DS} = V_{GS}, I_D = 250\mu A$	$V_{GS(TH)}$	1.4	1.6	2.2	V
Gate Body Leakage	$V_{GS} = \pm 20V, V_{DS} = 0V$	I_{GSS}	--	--	± 100	nA
Drain-Source Leakage Current	$V_{GS} = 0V, V_{DS} = 100V$	I_{DSS}	--	--	1	μA
	$V_{GS} = 0V, V_{DS} = 100V$ $T_J = 125^\circ\text{C}$		--	--	100	
Drain-Source On-State Resistance (Note 4)	$V_{GS} = 10V, I_D = 36A$	$R_{DS(on)}$	--	7.4	10	m Ω
	$V_{GS} = 4.5V, I_D = 36A$		--	9.1	14	
Forward Transconductance (Note 4)	$V_{DS} = 10V, I_D = 9A$	g_{fs}	--	53	--	S
Dynamic (Note 5)						
Total Gate Charge	$V_{DS} = 50V, I_D = 12A,$ $V_{GS} = 4.5V$	Q_g	--	13	--	nC
Total Gate Charge	$V_{DS} = 50V, I_D = 12A,$ $V_{GS} = 10V$	Q_g	--	25	--	nC
Gate-Source Charge		Q_{gs}	--	5.3	--	
Gate-Drain Charge		Q_{gd}	--	3.8	--	
Input Capacitance	$V_{DS} = 60V, V_{GS} = 0V,$ $f = 1.0MHz$	C_{iss}	--	1363	--	pF
Output Capacitance		C_{oss}	--	228	--	
Reverse Transfer Capacitance		C_{rss}	--	26	--	
Gate Resistance	$f = 1.0MHz$	R_g	--	0.5	--	Ω
Switching (Note 6)						
Turn-On Delay Time	$V_{DD} = 50V, R_G = 6\Omega,$ $I_D = 12A, V_{GS} = 10V$	$t_{d(on)}$	--	8.6	--	ns
Turn-On Rise Time		t_r	--	24	--	
Turn-Off Delay Time		$t_{d(off)}$	--	26	--	
Turn-Off Fall Time		t_f	--	52	--	
Source-Drain Diode						
Forward Voltage (Note 4)	$I_S = 36A, V_{GS} = 0V$	V_{SD}	--	--	1.1	V
Reverse Recovery Time	$I_S = 12A,$ $di/dt = 100A/\mu s$	t_{rr}	--	62	--	ns
Reverse Recovery Charge		Q_{rr}	--	95	--	nC

Notes:

- Pulse test: Pulse Width $\leq 300\mu s$, duty cycle $\leq 2\%$.
- Defined by design. Not subject to production test.
- Switching time is essentially independent of operating temperature.

ORDERING INFORMATION

ORDERING CODE	PACKAGE	PACKING
TQM100NH10LCR RLG	PDFN56U	2,500pcs / 13" Reel

CHARACTERISTICS CURVES

($T_A = 25^\circ\text{C}$ unless otherwise noted)

Output Characteristics

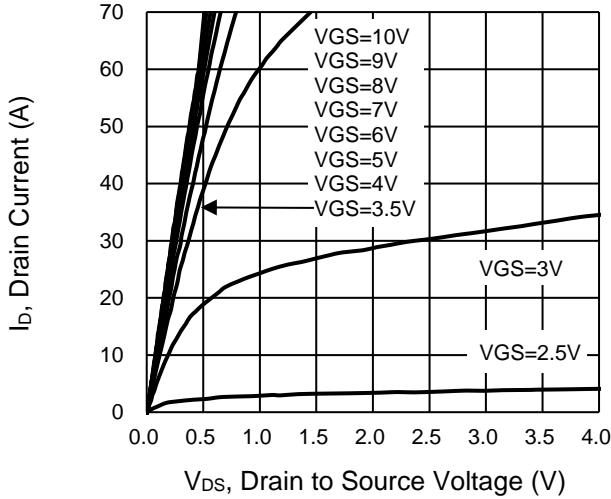

Transfer Characteristics

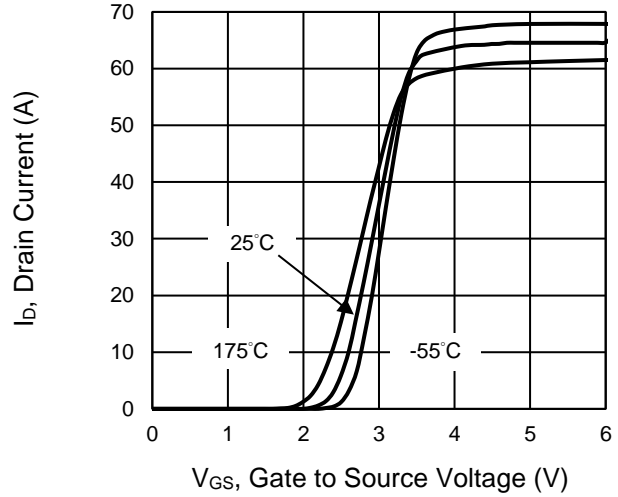

On-Resistance vs. Drain Current

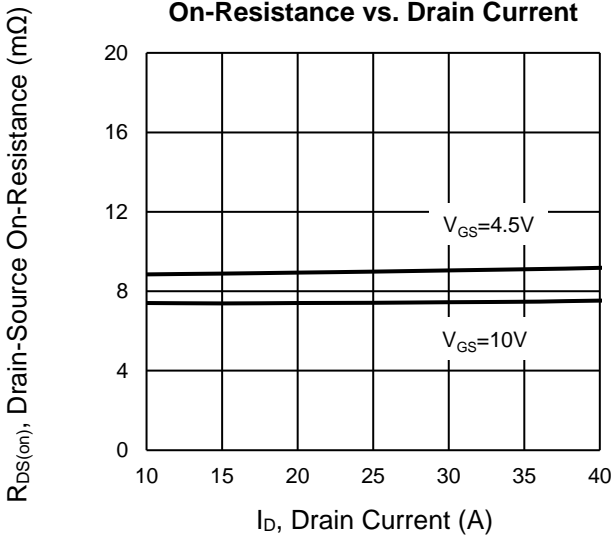

Gate-Source Voltage vs. Gate Charge

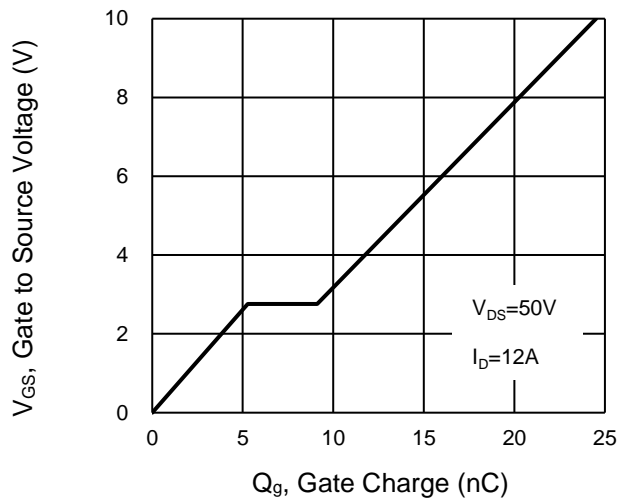

On-Resistance vs. Junction Temperature

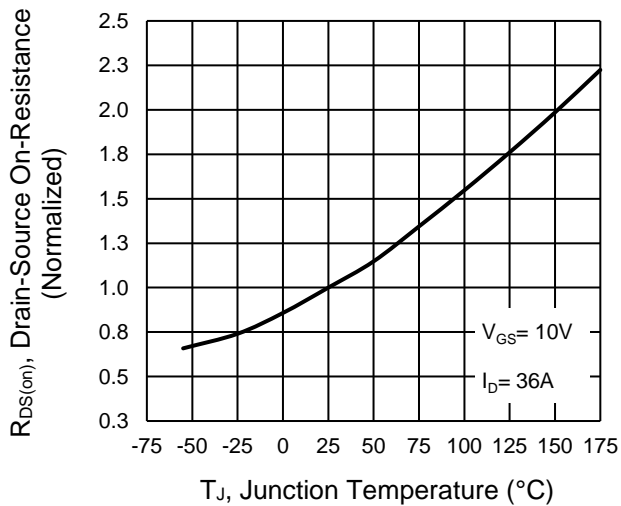

On-Resistance vs. Gate-Source Voltage

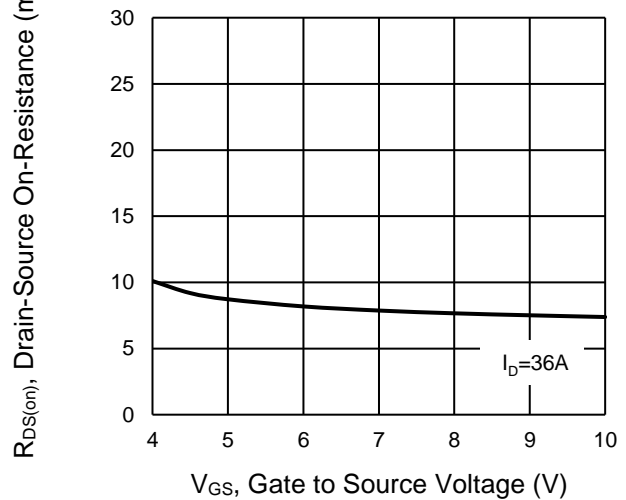

CHARACTERISTICS CURVES

($T_A = 25^\circ\text{C}$ unless otherwise noted)

Capacitance vs. Drain-Source Voltage

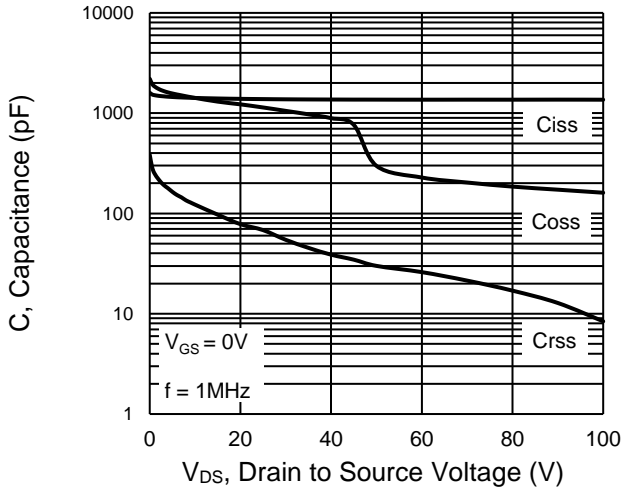

BV_{DSS} vs. Junction Temperature

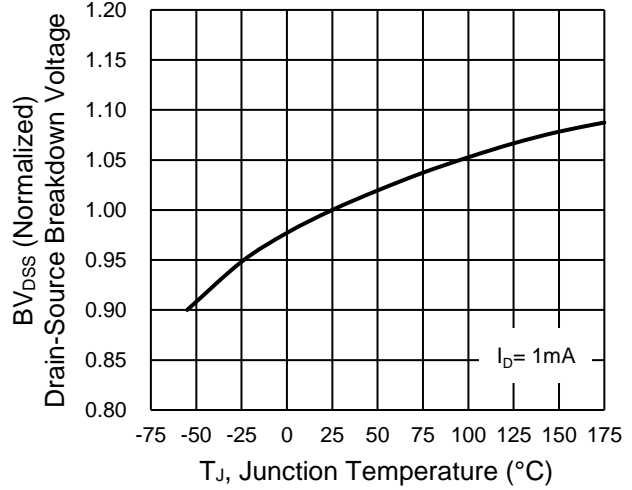

Maximum Safe Operating Area, Junction-to-Case

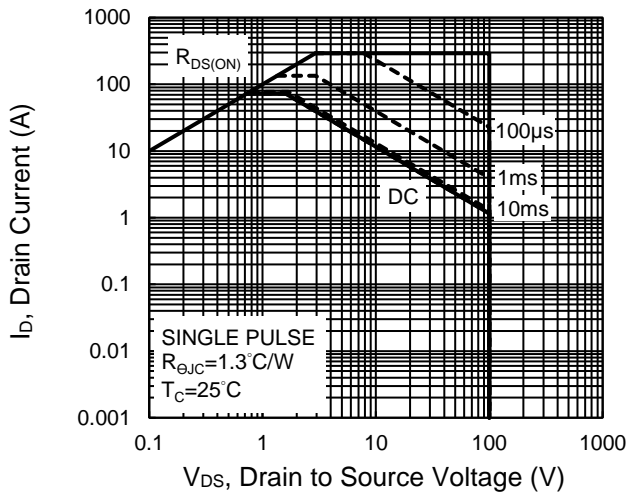

Source-Drain Diode Forward Current vs. Voltage

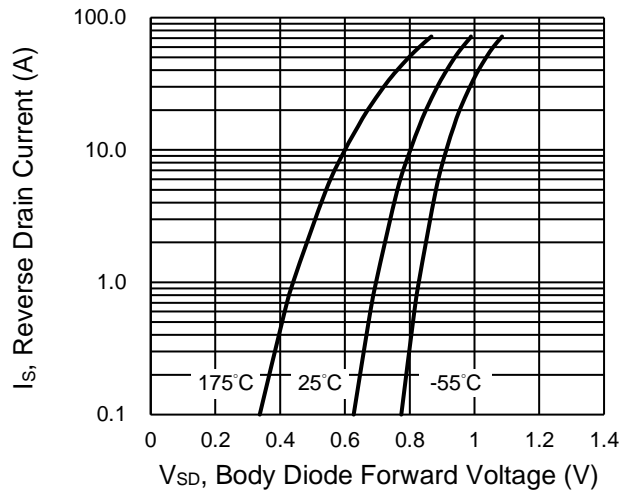

Normalized Thermal Transient Impedance, Junction-to-Case

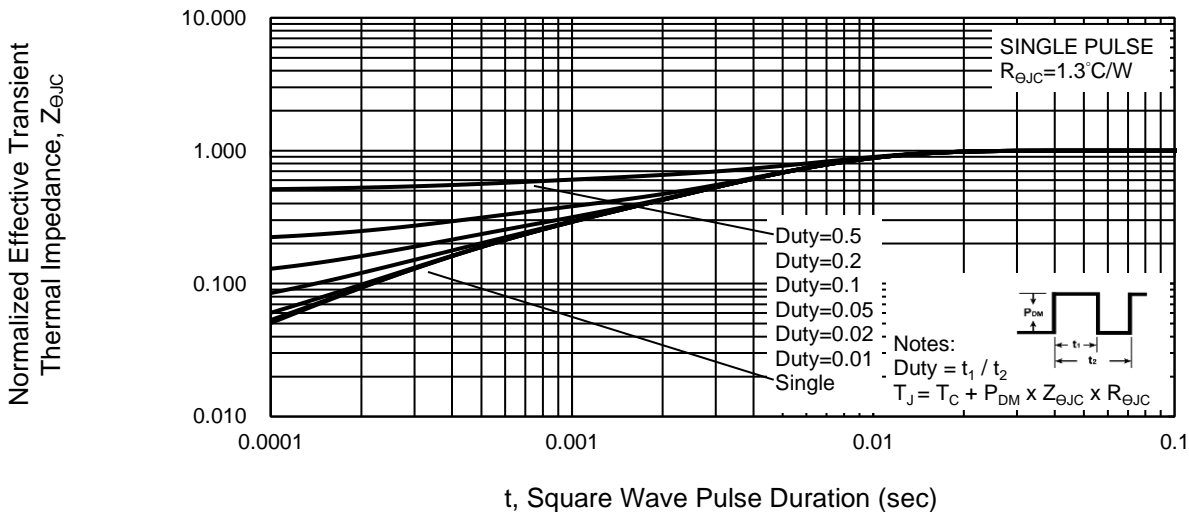

CHARACTERISTICS CURVES

($T_A = 25^\circ\text{C}$ unless otherwise noted)

Power Dissipation

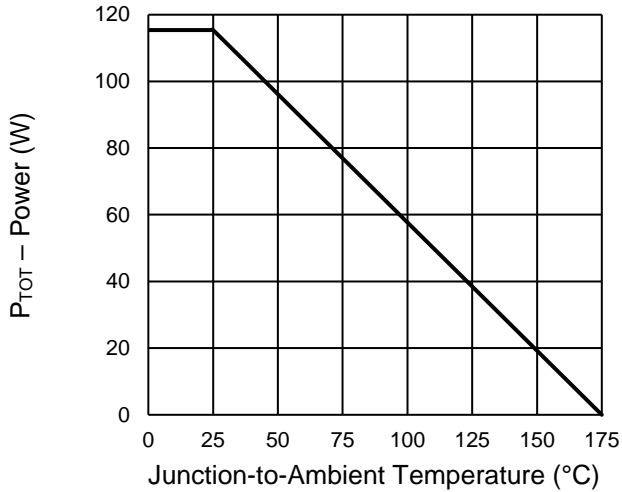

Drain Current

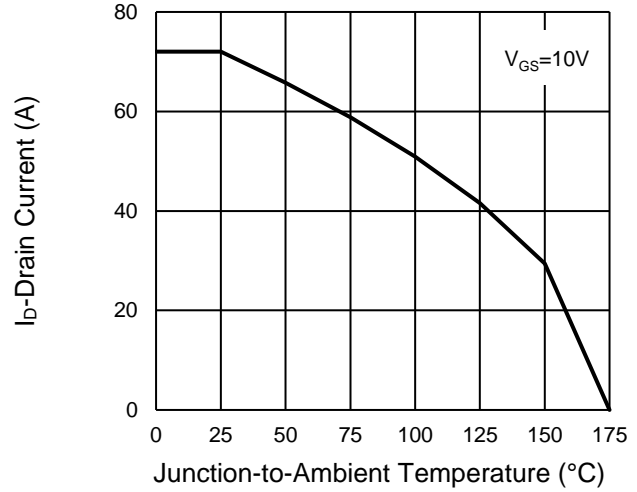

Normalized gate threshold voltage vs Temperature

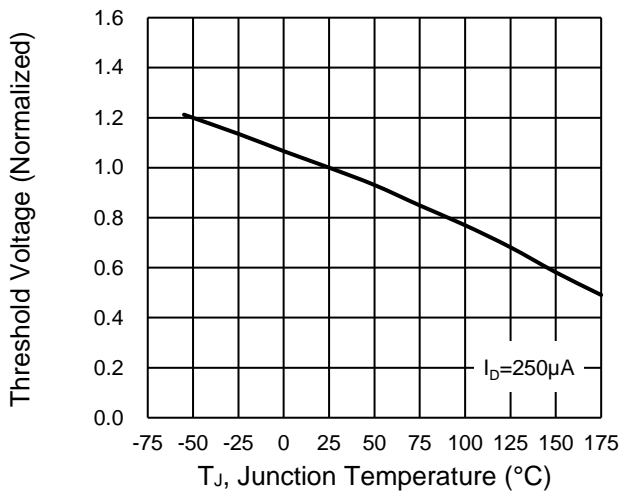

PACKAGE OUTLINE DIMENSIONS (Unit: Millimeters)

PDFN56U

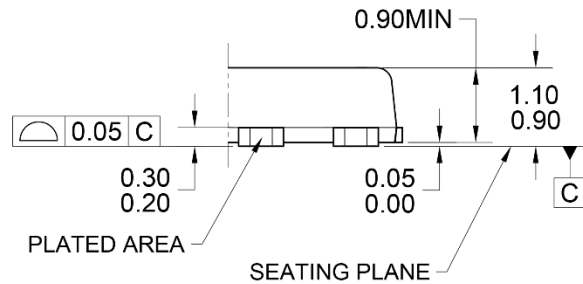
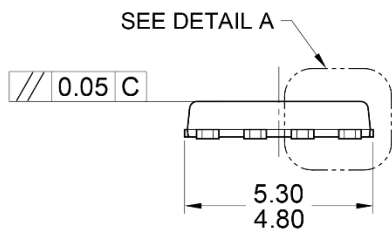
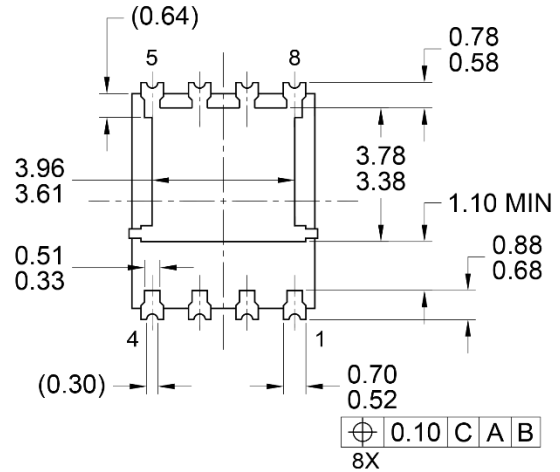
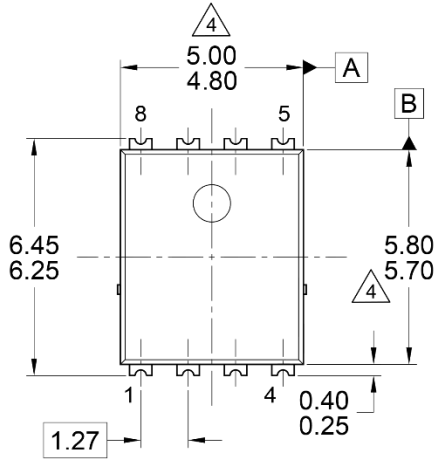

DETAIL A
(SCALE 2:1)

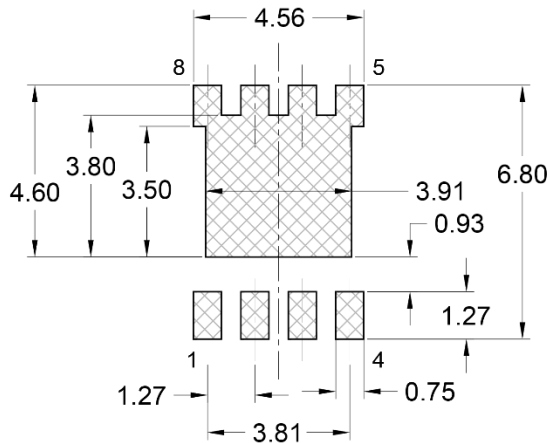

SUGGESTED PAD LAYOUT
(REFERENCE ONLY)

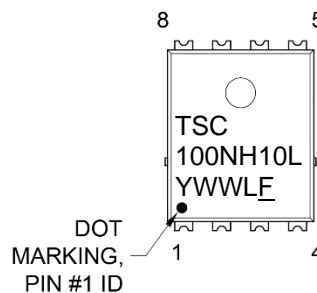

MARKING DIAGRAM

NOTES: UNLESS OTHERWISE SPECIFIED

1. ALL DIMENSIONS ARE IN MILLIMETERS.
2. DIMENSIONING AND TOLERANCING PER ASME Y14.5M-1994.
3. PACKAGE OUTLINE REFERENCE: JEITA ED-7500B, EIAJ SC-111BB.
4. MOLDED PLASTIC BODY DIMENSIONS DO NOT INCLUDE MOLD FLASH, PROTRUSIONS OR GATE BURRS.
5. DWG NO. REF: HQ2SD07-PDFN56U-023 REV B.

- 100NH10L = Device marking
 Y = Year code
 WW = Week code (01~52)
 L = Lot code (1~9,A~Z)
 F = Factory code
 - = AEC-Q101 qualified

Notice

Specifications of the products displayed herein are subject to change without notice. TSC or anyone on its behalf, assumes no responsibility or liability for any errors or inaccuracies.

Purchasers are solely responsible for the choice, selection, and use of TSC products and TSC assumes no liability for application assistance or the design of Purchasers' products.

Information contained herein is intended to provide a product description only. No license, express or implied, to any intellectual property rights is granted by this document. Except as provided in TSC's terms and conditions of sale for such products, TSC assumes no liability whatsoever, and disclaims any express or implied warranty, relating to sale and/or use of TSC products including liability or warranties relating to fitness for a particular purpose, merchantability, or infringement of any patent, copyright, or other intellectual property right.

The products shown herein are not designed for use in medical, life-saving, or life-sustaining applications. Customers using or selling these products for use in such applications do so at their own risk and agree to fully indemnify TSC for any damages resulting from such improper use or sale.