

PerFET™ Power Transistor

FEATURES

- Excellent FOM
- AEC-Q101 Qualified
- Wettable Flank leads for Enhanced AOI
- 100% UIS and Rg tested
- 175°C Operating Junction Temperature
- RoHS Compliant
- Halogen-Free

APPLICATIONS

- Automotive Applications
- Solenoid and Motor Drivers
- DC-DC Converters

PRODUCT SUMMARY			
PARAMETER	VALUE	UNIT	
V_{DS}	40	V	
$R_{DS(on)}$ (max)	$V_{GS} = 10V$	3.2	mΩ
	$V_{GS} = 7V$	3.8	
Q_g	$V_{GS} = 10V$	45	nC



PDFN56U

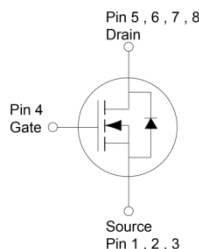
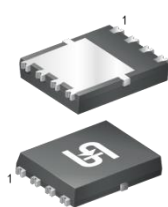

Note: MSL 1 (Moisture Sensitivity Level) per J-STD-020

ABSOLUTE MAXIMUM RATINGS ($T_A = 25^\circ\text{C}$ unless otherwise noted)				
PARAMETER		SYMBOL	LIMIT	UNIT
Drain-Source Voltage		V_{DS}	40	V
Gate-Source Voltage		V_{GS}	± 20	V
Continuous Drain Current, Silicon limited	$T_C = 25^\circ\text{C}$	I_D	143	A
Continuous Drain Current (Note 1)	$T_C = 25^\circ\text{C}$	I_D	81	A
	$T_C = 100^\circ\text{C}$		81	
	$T_A = 25^\circ\text{C}$		23	
Pulsed Drain Current (Note 2)		I_{DM}	324	A
Single Pulse Avalanche Current (Note 3)		I_{AS}	32.4	A
Single Pulse Avalanche Energy (Note 3)		E_{AS}	157	mJ
Total Power Dissipation	$T_C = 25^\circ\text{C}$	P_D	115	W
	$T_C = 125^\circ\text{C}$		38	
Operating Junction and Storage Temperature Range		T_J, T_{STG}	-55 to +175	$^\circ\text{C}$

THERMAL RESISTANCE			
PARAMETER	SYMBOL	MAXIMUM	UNIT
Thermal Resistance – Junction to Case	$R_{\theta JC}$	1.3	$^\circ\text{C/W}$
Thermal Resistance – Junction to Ambient (Note 4)	$R_{\theta JA}$	50	$^\circ\text{C/W}$

NOTE:

1. Package current limit.
2. Pulse Width $\leq 100\mu\text{s}$.
3. $L = 0.3\text{mH}$, $V_{GS} = 10V$, $R_G = 25\Omega$, Starting $T_J = 25^\circ\text{C}$.
4. Device on a PCB FR4 with 1 in² (single layer, 2 oz thick) copper area for drain connection.

ELECTRICAL CHARACTERISTICS ($T_A = 25^\circ\text{C}$ unless otherwise noted)						
PARAMETER	CONDITIONS	SYMBOL	MIN	TYP	MAX	UNIT
Static						
Drain-Source Breakdown Voltage	$V_{GS} = 0\text{V}, I_D = 1\text{mA}$	BV_{DSS}	40	--	--	V
Gate Threshold Voltage	$V_{GS} = V_{DS}, I_D = 250\mu\text{A}$	$V_{GS(TH)}$	2.4	3	3.6	V
Gate-Source Leakage Current	$V_{GS} = \pm 20\text{V}, V_{DS} = 0\text{V}$	I_{GSS}	--	--	± 100	nA
Drain-Source Leakage Current	$V_{GS} = 0\text{V}, V_{DS} = 40\text{V}$	I_{DSS}	--	--	1	μA
	$V_{GS} = 0\text{V}, V_{DS} = 40\text{V}$ $T_J = 125^\circ\text{C}$		--	--	100	
Drain-Source On-State Resistance (Note 5)	$V_{GS} = 10\text{V}, I_D = 40\text{A}$	$R_{DS(on)}$	--	2.7	3.2	m Ω
	$V_{GS} = 7\text{V}, I_D = 40\text{A}$		--	3.2	3.8	
Forward Transconductance (Note 5)	$V_{DS} = 10\text{V}, I_D = 10\text{A}$	g_{fs}	--	56	--	S
Dynamic (Note 6)						
Total Gate Charge	$V_{GS} = 7\text{V}, V_{DS} = 20\text{V},$ $I_D = 23\text{A}$	Q_g	--	32.4	48.6	nC
Total Gate Charge	$V_{GS} = 10\text{V}, V_{DS} = 20\text{V},$ $I_D = 23\text{A}$	Q_g	--	45	67.5	
Gate-Source Charge		Q_{gs}	--	14	28	
Gate-Drain Charge		Q_{gd}	--	9.5	19	
Input Capacitance	$V_{GS} = 0\text{V}, V_{DS} = 25\text{V},$ $f = 1.0\text{MHz}$	C_{iss}	--	2896	4344	pF
Output Capacitance		C_{oss}	--	562	1124	
Reverse Transfer Capacitance		C_{rss}	--	32	64	
Gate Resistance	$f = 1.0\text{MHz}$	R_g	--	0.7	--	Ω
Switching (Note 7)						
Turn-On Delay Time	$V_{GS} = 10\text{V}, V_{DS} = 20\text{V},$ $I_D = 23\text{A}, R_G = 3.3\Omega$	$t_{d(on)}$	--	15.7	--	ns
Rise Time		t_r	--	71	--	
Turn-Off Delay Time		$t_{d(off)}$	--	28.6	--	
Fall Time		t_f	--	13	--	
Source-Drain Diode						
Diode Forward Voltage (Note 5)	$V_{GS} = 0\text{V}, I_S = 40\text{A}$	V_{SD}	--	--	1.1	V
Reverse Recovery Time	$I_S = 23\text{A},$ $di/dt = 100\text{A}/\mu\text{s}$	t_{rr}	--	42	--	ns
Reverse Recovery Charge		Q_{rr}	--	43	--	nC

Notes:

- Pulse test: Pulse Width $\leq 300\mu\text{s}$, duty cycle $\leq 2\%$.
- Defined by design. Not subject to production test.
- Switching time is essentially independent of operating temperature.

ORDERING INFORMATION

ORDERING CODE	PACKAGE	PACKING
TQM032NH04CR RLG	PDFN56U	2,500pcs / 13" Reel

CHARACTERISTICS CURVES

($T_A = 25^\circ\text{C}$ unless otherwise noted)

Output Characteristics

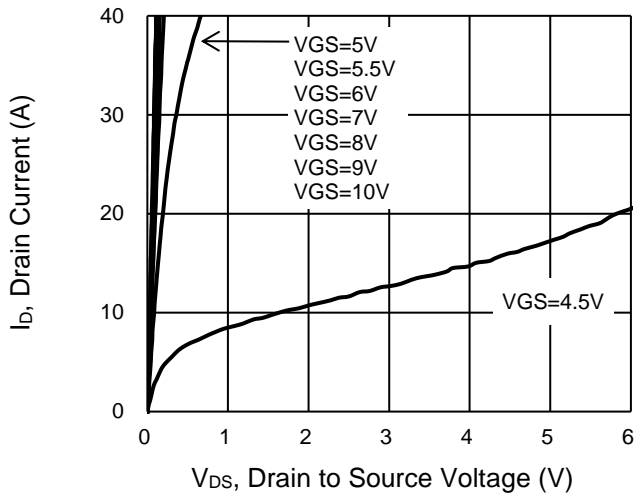

Transfer Characteristics

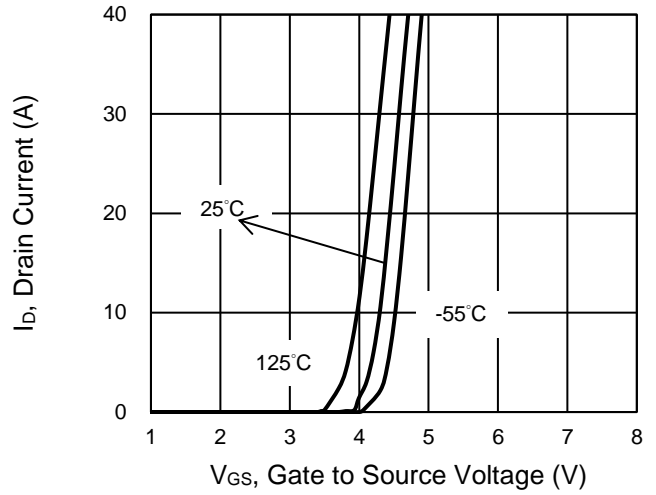

On-Resistance vs. Drain Current

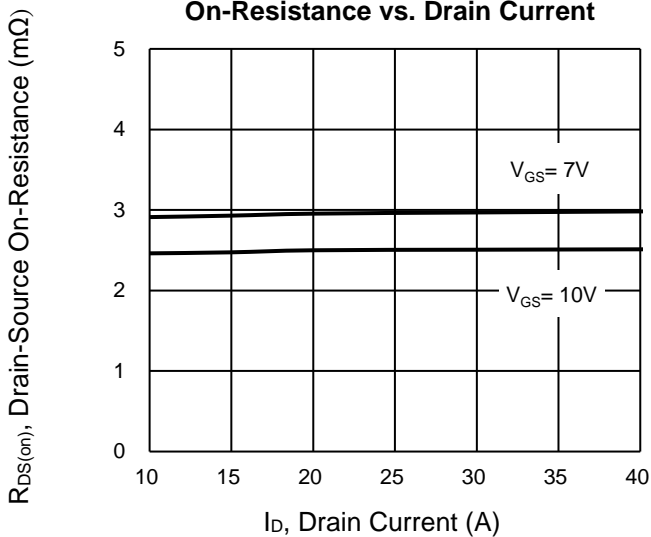

Gate-Source Voltage vs. Gate Charge

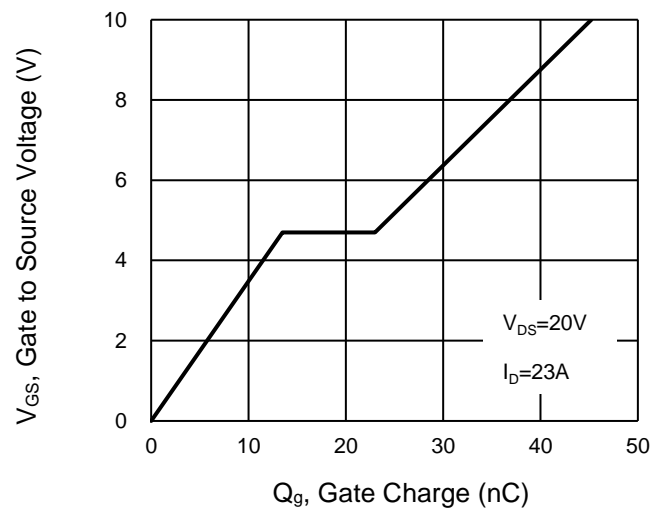

On-Resistance vs. Junction Temperature

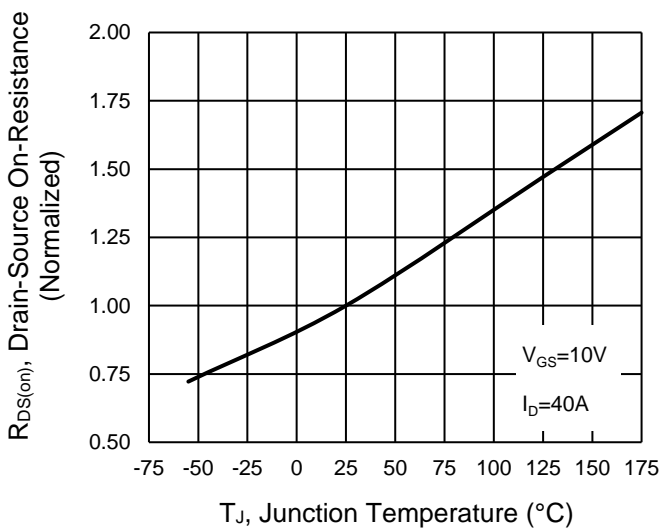

On-Resistance vs. Gate-Source Voltage

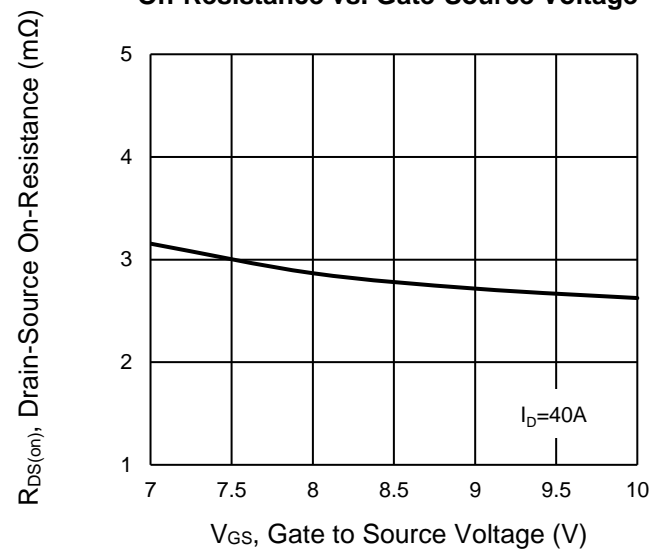

CHARACTERISTICS CURVES

($T_A = 25^\circ\text{C}$ unless otherwise noted)

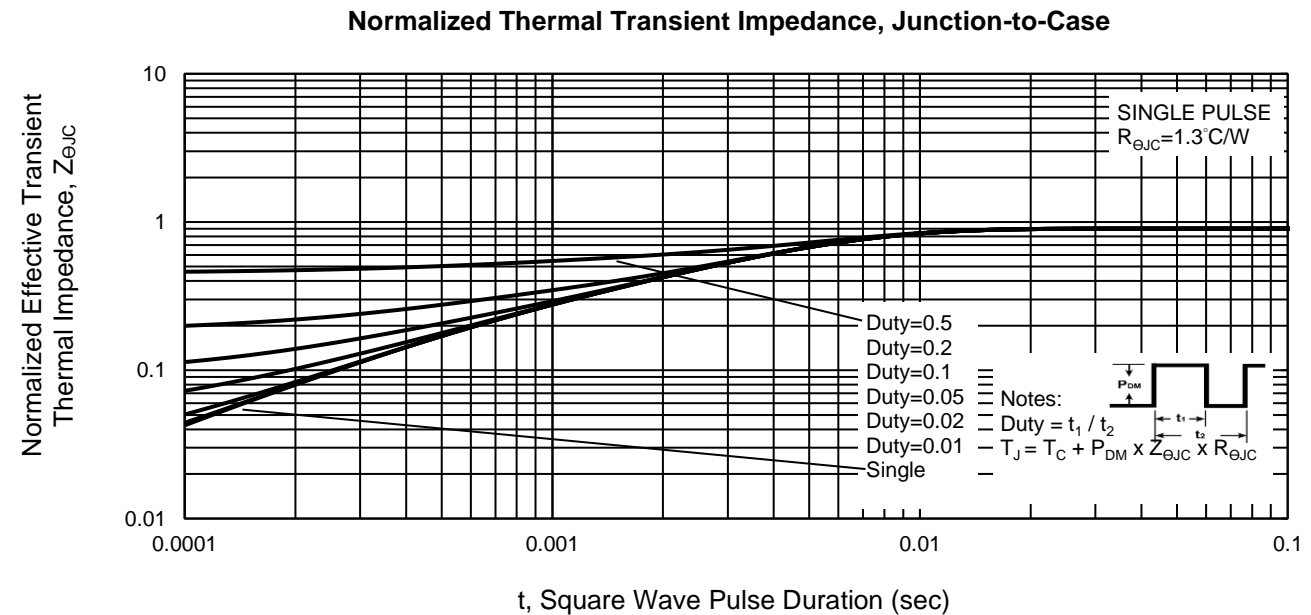
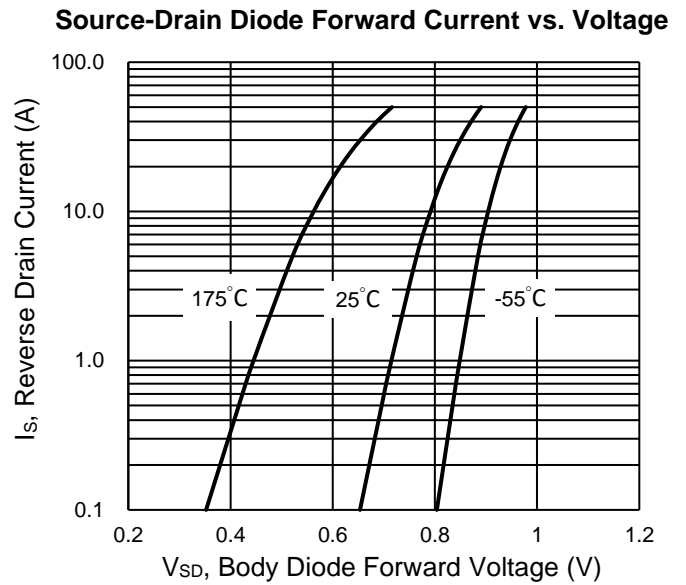
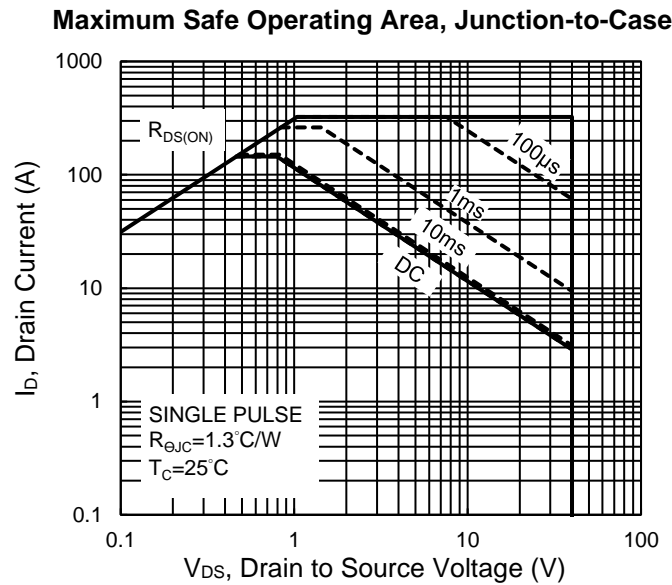
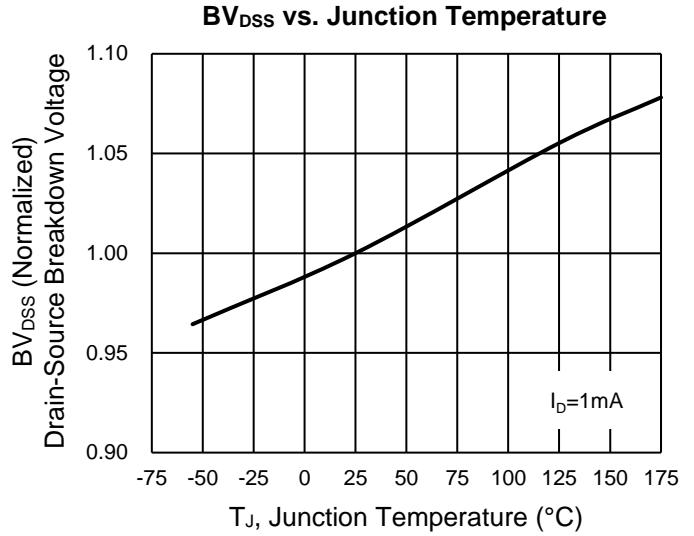
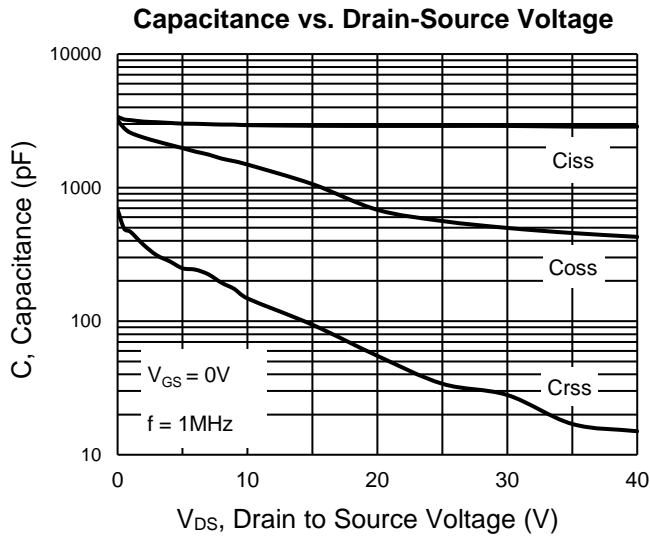

CHARACTERISTICS CURVES

($T_A = 25^\circ\text{C}$ unless otherwise noted)

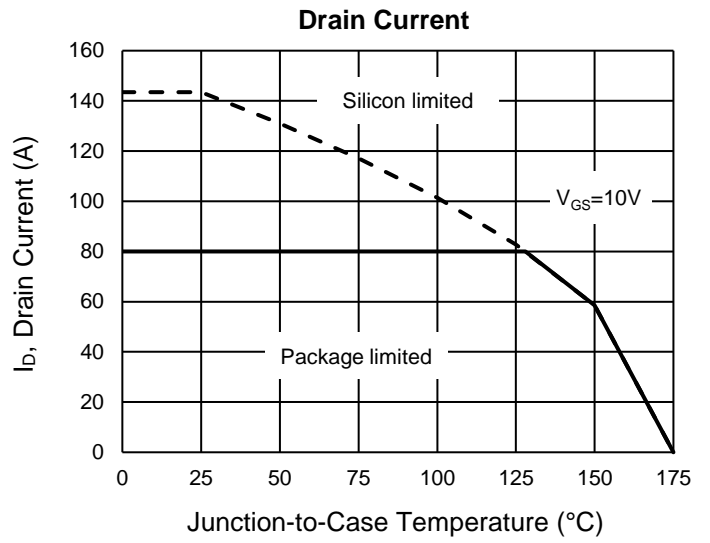
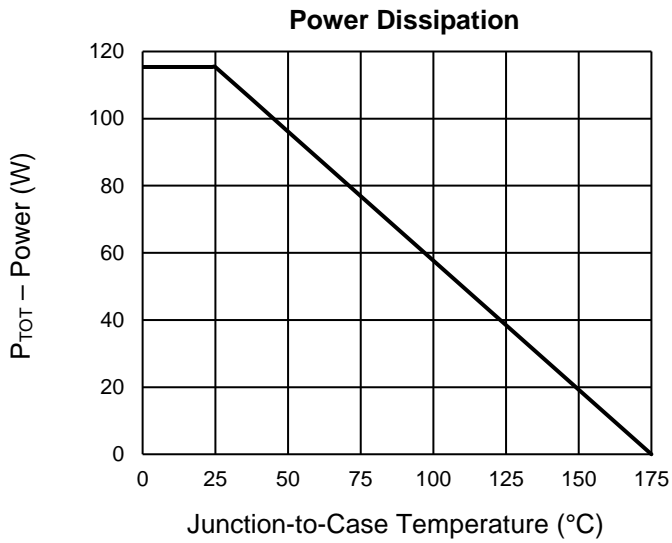

Normalized gate threshold voltage vs Temperature

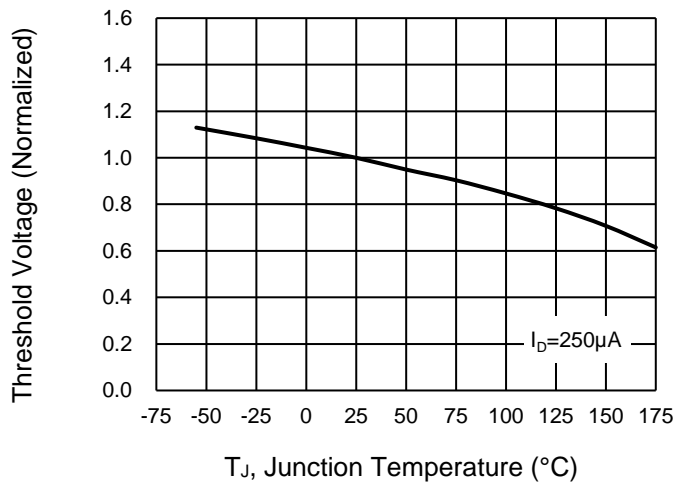

PACKAGE OUTLINE DIMENSIONS (Unit: Millimeters)

PDFN56U

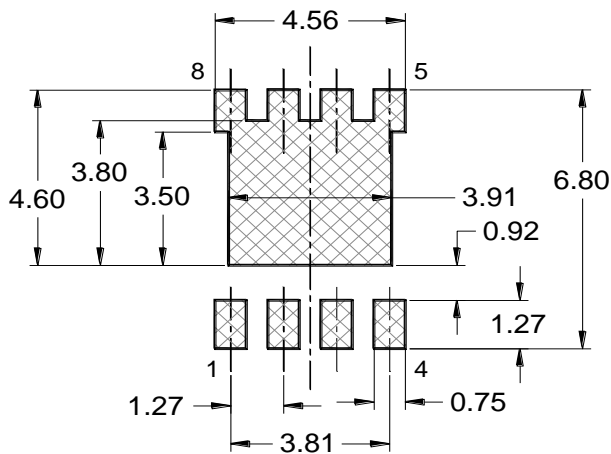
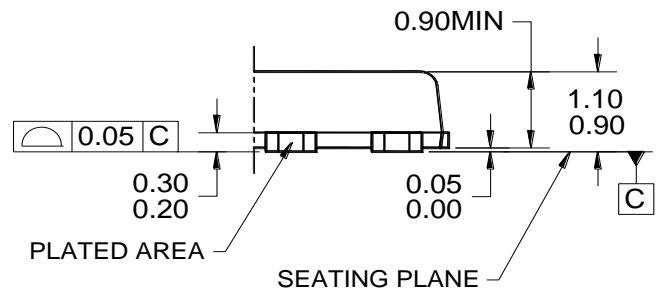
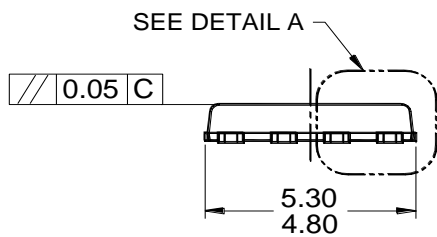
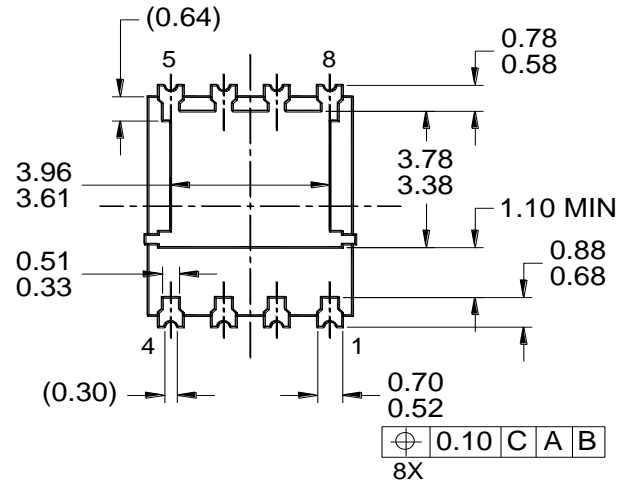
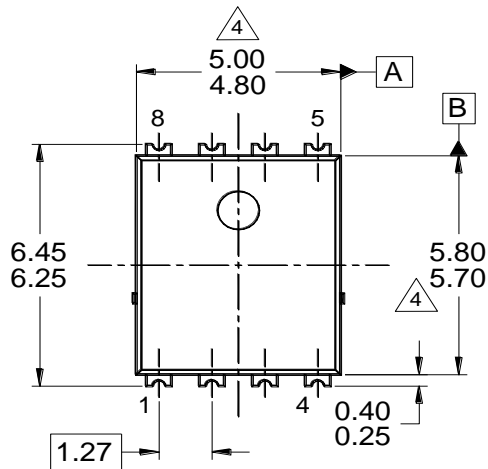

SUGGESTED PAD LAYOUT
(REFERENCE ONLY)

DETAIL A
(SCALE 2:1)

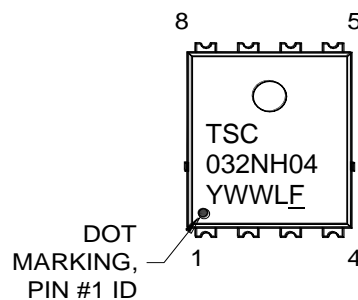

MARKING DIAGRAM

NOTES: UNLESS OTHERWISE SPECIFIED

1. ALL DIMENSIONS ARE IN MILLIMETERS.
2. DIMENSIONING AND TOLERANCING PER ASME Y14.5M-1994.
3. PACKAGE OUTLINE REFERENCE: JEITA ED-7500B, EIAJ SC-111BB.
4. MOLDED PLASTIC BODY DIMENSIONS DO NOT INCLUDE MOLD FLASH, PROTRUSIONS OR GATE BURRS.
5. DWG NO. REF: HQ2SD07-PDFN56U-023 REV B.

- Y = YEAR CODE
 WW = WEEK CODE (01~52)
 L = LOT CODE (1~9, A~Z)
 F = FACTORY CODE
 - = AEC-Q101 QUALIFIED

Notice

Specifications of the products displayed herein are subject to change without notice. TSC or anyone on its behalf, assumes no responsibility or liability for any errors or inaccuracies.

Purchasers are solely responsible for the choice, selection, and use of TSC products and TSC assumes no liability for application assistance or the design of Purchasers' products.

Information contained herein is intended to provide a product description only. No license, express or implied, to any intellectual property rights is granted by this document. Except as provided in TSC's terms and conditions of sale for such products, TSC assumes no liability whatsoever, and disclaims any express or implied warranty, relating to sale and/or use of TSC products including liability or warranties relating to fitness for a particular purpose, merchantability, or infringement of any patent, copyright, or other intellectual property right.

The products shown herein are not designed for use in medical, life-saving, or life-sustaining applications. Customers using or selling these products for use in such applications do so at their own risk and agree to fully indemnify TSC for any damages resulting from such improper use or sale.